

Prosthetic manual
Full-arch screw-retained
rehabilitations

PREMIUM KOHNO SHELTA

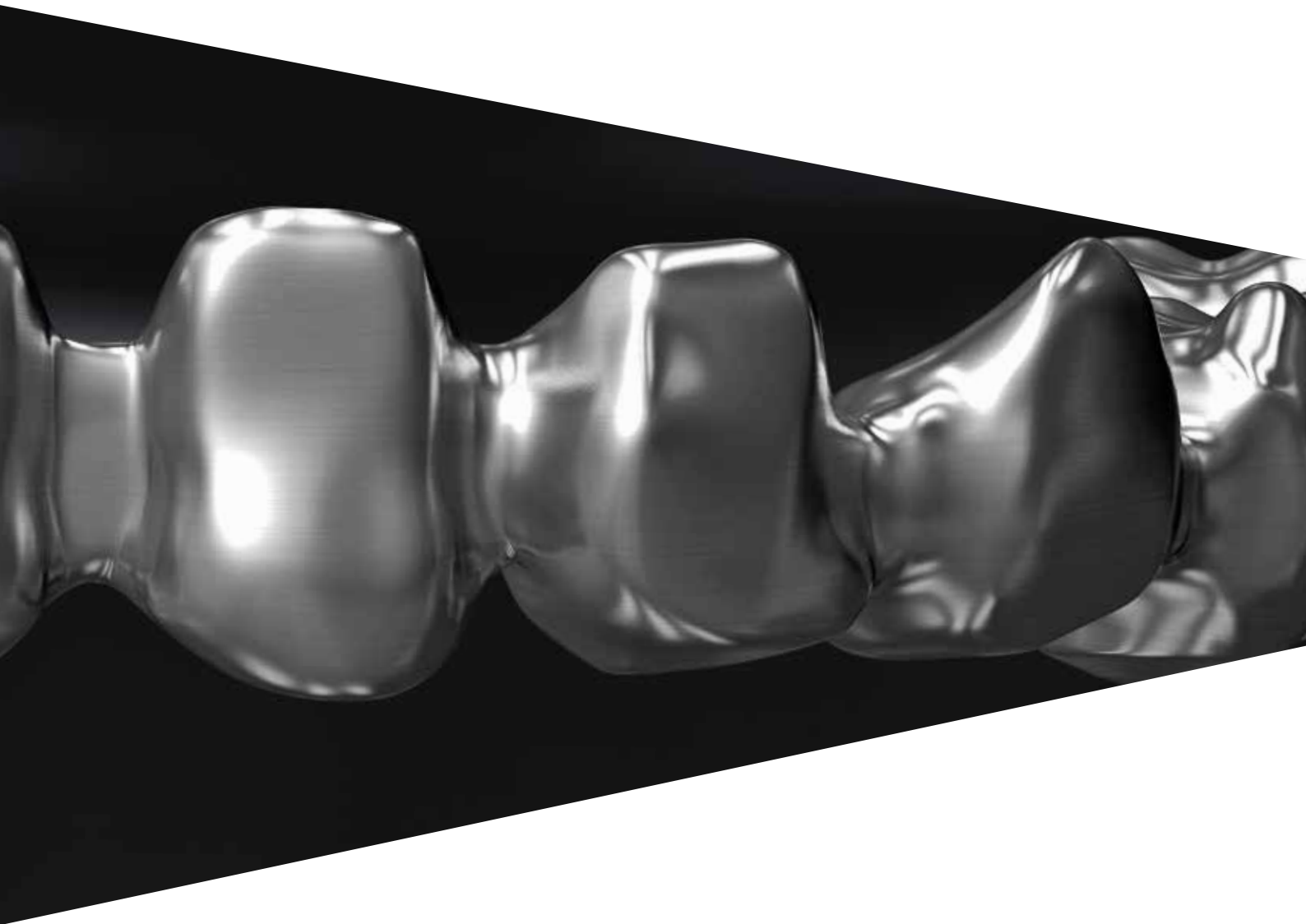

Some products included in this manual may not be regulatory cleared/released for sale in the U.S. market.
Please contact the local Sweden & Martina or distributor sales office for current products availability.

Prosthetic manual

Full-arch screw-retained rehabilitations



Guide to the sequence of use of prosthetic components

6



Connection platform

10

Overview of diameters, emergence profiles, implant connections and colour codes

10

Possible combinations of implant-prosthetic diameters

12

Collex connection

14

Contracone seal

15

Implant Platform Switching

15



Prosthetics instruments

16

Screw Kit

16

Drivers for connecting screws

20

CRI5-KIT torque-control ratchet

22



Protocols for use

24

Techniques for taking impressions and making models

24

Total rehabilitations with Simple posts

34

Total rehabilitations with totally castable posts or with castable posts with alloy base

42

Total rehabilitations with intermediate abutments

46

Total rehabilitations with Plain abutments

50

Total rehabilitations with disparallel screwed prosthesis (P.A.D. abutments)

56

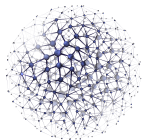

General indications

84

Composition of materials

84

Advice for overcasting with base alloys

91

General clinical indications

92



General bibliography for Sweden & Martina implants

102



PREMIUM PLATFORM SWITCHING

Morphology based on clinical evidence.



KOHNO PLATFORM SWITCHING

Characterized by an accentuated taper and a bevel for Platform Switching.

PREMIUM KOHNO



PREMIUM Ø 3.30 MM

Dedicated to intraforaminal sectors and indicated for thin bone crests or to replace upper lateral incisors.



SHORTY IMPLANTS

Intended for bone crests with reduced vertical development, available with both Straight and Platform Switching profiles.

KOHNO STRAIGHT

The same connection combined with a tapered morphology extend the range of use of the family.



PREMIUM STRAIGHT

An implant with 18 years of clinical history.



SHELTA

SHELTA STANDARD

Three implant diameters in a single prosthetic connection.



SHELTA SL

A broad thread designed to guarantee maximum primary stability.



Guide to the sequence of use of prosthetic components

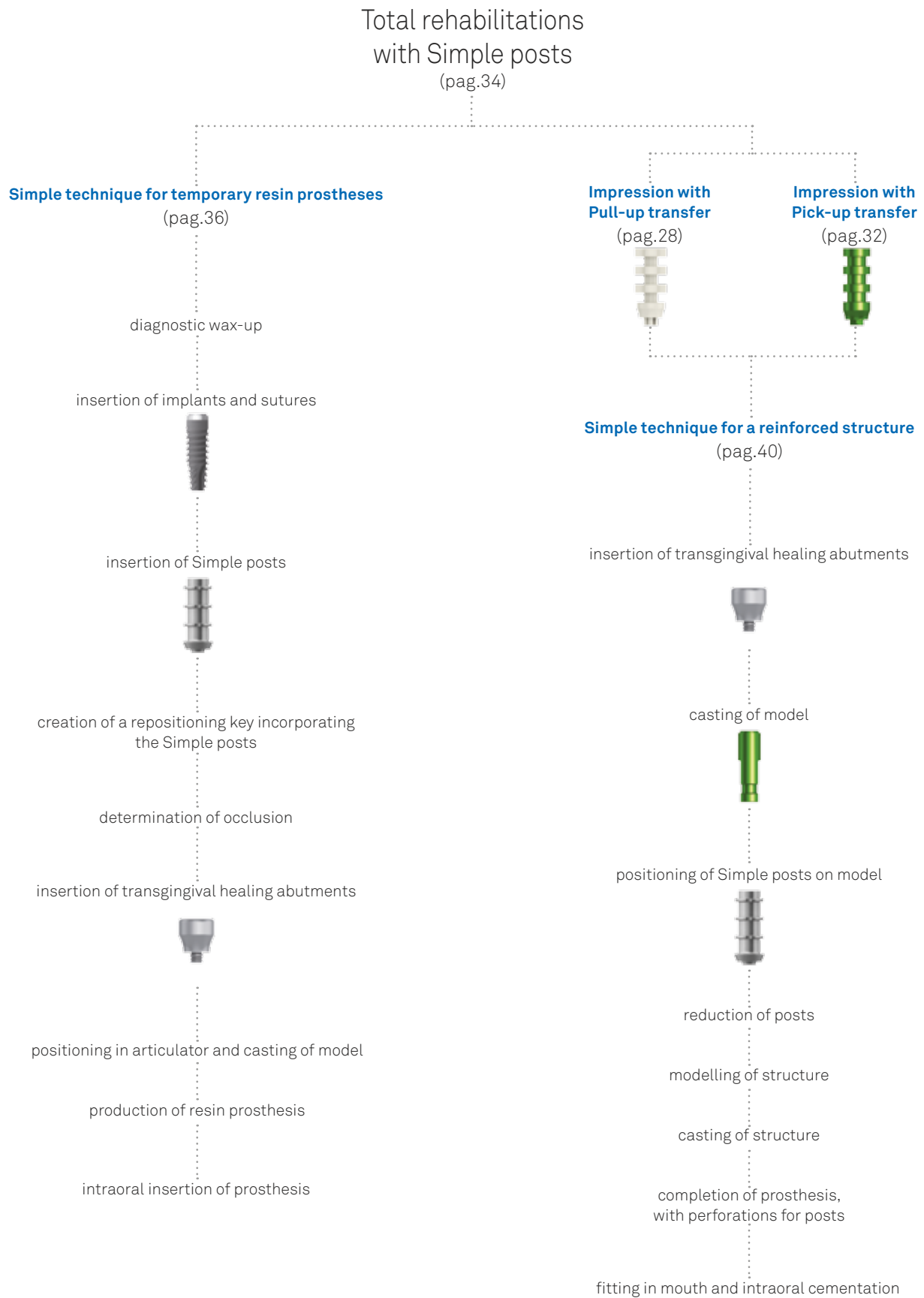

Total rehabilitations with totally castable posts or with castable posts with metal base
(pag.42)

Impression with Pull-up transfer
(pag.28)



Impression with Pick-up transfer
(pag.32)



Production of a prosthesis with a reinforced structure
(pag.44)

insertion of transgingival healing abutments



casting of model



positioning of castable posts on model

totally castable



castable with gold alloy base



castable with base in cobalt-chrome



reduction of posts

modelling of structure

casting of structure

completion of prosthesis

fitting in mouth and intraoral fixation

Total rehabilitations with intermediate abutments
(pag.46)

Impression with Pull-up transfer
(pag.28)



Impression with Pick-up transfer
(pag.32)



Production of a prosthesis with a reinforced structure
(pag.48)

insertion of transgingival healing abutments



casting of model



positioning of intermediate abutments on model



reduction of posts

modelling of structure

casting of structure

completion of prosthesis

fitting in mouth and intraoral fixation

...continued

Total rehabilitations with Plain abutments (pag.50)

Immediate loading (pag.52)

insertion of Plain abutments



impression of Plain abutments



Plain healing cap screwed on



casting of model with Plain analogues



castable sleeves screwed on



reduction of sleeves

modelling and production of the truss by casting or with CAD/CAM methods

completion of prosthesis

fitting in mouth and intraoral fixation

Immediate loading on 4 or 6 implants: cementation technique (pag.66)

Impression on P.A.D. abutments with POM caps



(pag.66)

Impression on P.A.D. abutments with Pick-up transfer



(pag.68)

Insertion of healing caps in titanium in PEEK



Production of a prosthesis with a reinforced structure

(pag.70)

casting of model with P.A.D. analogues



titanium sleeves screwed on



insertion of castable cylinders on titanium sleeves



reduction of sleeves

modelling and production of the truss by casting or with CAD/CAM methods

completion of prosthesis, with perforations for posts

transfer of titanium sleeves to oral cavity

check and intraoral cementation of prosthesis on titanium sleeves

Disparallel Screwed
Prosthesis
(P.A.D. abutments)
(pag.56)

**Insertion of straight
P.A.D. abutments**



(pag.62)

**Insertion of angled
P.A.D. abutments**



(pag.64)

Immediate loading on 4 or 6 implants:
Direct Prosthetic Framework (D.P.F.) technique
(pag.74)

**Production of a prosthesis with
a reinforced structure**
(pag.76)

insertion of D.P.F. sleeves and castable centring devices



fixing of centring devices with resin and removal of
sleeves and resin structure from the oral cavity

thickening of the resin structure and reduction of
the D.P.F. sleeves

casting of truss

intraoral cementation of truss to sleeves

impression incorporating truss

repositioning of P.A.D. analogues in impression



casting of model

retrieval of truss from impression and completion
of prosthesis

check and intraoral screwing of prosthesis onto
P.A.D. abutments

Deferred loading on 4 or 6 implants
(pag.82)

**Production of a definitive prosthesis by
casting or with CAD/CAM methods**

removal of the temporary prosthesis

impression on P.A.D. abutments with Pick-up
transfer and individual tray



repositioning of temporary prosthesis in mouth

casting of precision model with P.A.D. analogues



positioning of castable posts with or without metal base
on model



modelling of structure

production of the structure by casting or with CAD/CAM
methods

completion of prosthesis

intraoral insertion of prosthesis

Overview of diameters, emergence profiles, implant connections and colour codes

The dimensions of hexagons, collars and coupling and connecting screw diameters are shown in the chart below. The chart also shows the diameters of the posts compatible with every single implant connection diameter and a schematic diagram of the resulting coupling.

	Premium			Premium Kohno	
Ø implant	3.30 Straight	3.80 Straight	3.80 SP	4.25 Straight	4.25 SP
colour code (on pack)					
maximum emergence Ø connection platform Ø	Ø 3.30	Ø 3.80	Ø 4.45 Ø 3.80	Ø 4.25	Ø 4.85 Ø 4.25
main dimensions					
external collar Ø	Ø 3.30	Ø 3.20	Ø 3.20	Ø 3.60	Ø 3.60
internal collar Ø	Ø 2.70	Ø 2.70	Ø 2.70	Ø 3.00	Ø 3.00
width across flats					
with post of smaller Ø		Ø 3.30	Ø 3.30		
prosthetic compatibility					
with post of compatible Ø	Ø 3.30	Ø 3.80	Ø 3.80	Ø 4.25	Ø 4.25
implant analogues					
closed-tray transfers for repositioning					
Pick-up transfers					
fixing screw (thread and colour)	M 1.8	M 1.8	M 1.8	M 2.0	M 2.0

All measurements are in mm, unless otherwise indicated.

		Kohno
5.00 Straight	5.00 SP	6.00 Straight
 Ø 5.00	 Ø 5.00 Ø 5.60	 Ø 6.00
 Ø 3.90 Ø 3.00	 Ø 3.90 Ø 3.00	 Ø 3.90 Ø 3.00
 Ø 5.00	 Ø 5.00 Ø 5.00SP	 Ø 5.00 Ø 6.00
 Ø 5.00	 Ø 5.00	 Ø 6.00
M 2.0	M 2.0	M 2.0

			Shelta
3.80	4.25	5.00	
 Ø 3.80	 Ø 4.25	 Ø 5.00	
 Ø 3.20 Ø 2.70	 Ø 3.20 Ø 2.70	 Ø 3.20 Ø 2.70	
 Ø 3.30 Ø 3.80	 Ø 3.80	 Ø 3.80	
 Ø 3.80	 Ø 3.80	 Ø 3.80	
M 1.8	M 1.8	M 1.8	

Possible combinations of implant-prosthetic diameters

As on pages 10–11, the implants on these pages are shown coupled with standard preformed posts to make it easier to see all the possible combinations of fixture diameters and the diameters of prosthetic components. Preformed posts are not dealt with in the protocols presented in this manual. The couplings that can be produced with the prosthetic solutions illustrated in the following sections are however the same.

Premium Straight and Kohno Straight: standard protocols (without Platform Switching technique)



Premium Straight
Ø 3.30 mm
post Ø 3.30 mm



Premium and Kohno
Straight Ø 3.80 mm
post Ø 3.80 mm



Premium and Kohno
Straight Ø 4.25 mm
post Ø 4.25 mm



Premium and Kohno
Straight Ø 5.00 mm
post Ø 5.00 mm



Kohno Straight
Ø 6.00 mm
post Ø 6.00 mm

Premium SP: protocols with implant Platform Switching technique



Premium SP
Ø 3.80 mm
post Ø 3.80 mm



Premium SP
Ø 4.25 mm
post Ø 4.25 mm



Premium SP Ø 5.00 mm
post Ø 5.00 mm

Premium SP: protocols with prosthesis Platform Switching technique



Premium SP
Ø 3.80 mm
post Ø 3.30 mm



Premium Straight
Ø 3.80 mm
post Ø 3.30 mm



Kohno Straight
Ø 6.00 mm
post Ø 5.00 mm

Shelta: standard protocols (without Platform Switching technique)



Shelta
 \varnothing 3.80 mm
 post \varnothing 3.80 mm

Shelta: protocols with prosthetic Platform Switching technique



Shelta
 \varnothing 3.80 mm
 post \varnothing 3.30 mm



Shelta
 \varnothing 4.25 mm
 post \varnothing 3.80 mm



Shelta
 \varnothing 5.00 mm
 post \varnothing 3.80 mm

Important warning

Given the reduced diameter of prosthetic components with a diameter of 3.30 mm, it is advisable to use them for prosthesis switching only on implants with a diameter of 3.80 mm for single crowns in frontal sectors (excluding premolars), and to support multiple prostheses in distal sectors.

Collex connection

The COLLEX connection, with 18 years of documented clinical success, has a large internal hexagon and a collar that guides the abutment into the internal implant connection. This interlocking solution gives the implant-prosthetic complex great stability and solidity, also helping to correctly distribute masticatory loads. The limitation of micromovement ensured by the presence of the collar increases the duration over time of prosthetic rehabilitations and protects implants against potentially harmful stresses.

The COLLEX connection exercises the same function of stability regardless of the implant emergence profile, which can be straight in the case of Straight implants or bevelled in the case of SP implants for the Platform Switching technique.

The collar on the COLLEX connection also acts as a guide to facilitate the engagement of the Easy Insert driver, the patented Sweden & Martina system for the mountless insertion of Premium, Kohno and Shelta implants that conserves the precision of the internal hexagon of the connection during implant insertion, an extremely important factor for the subsequent phase of prosthetic rehabilitation.

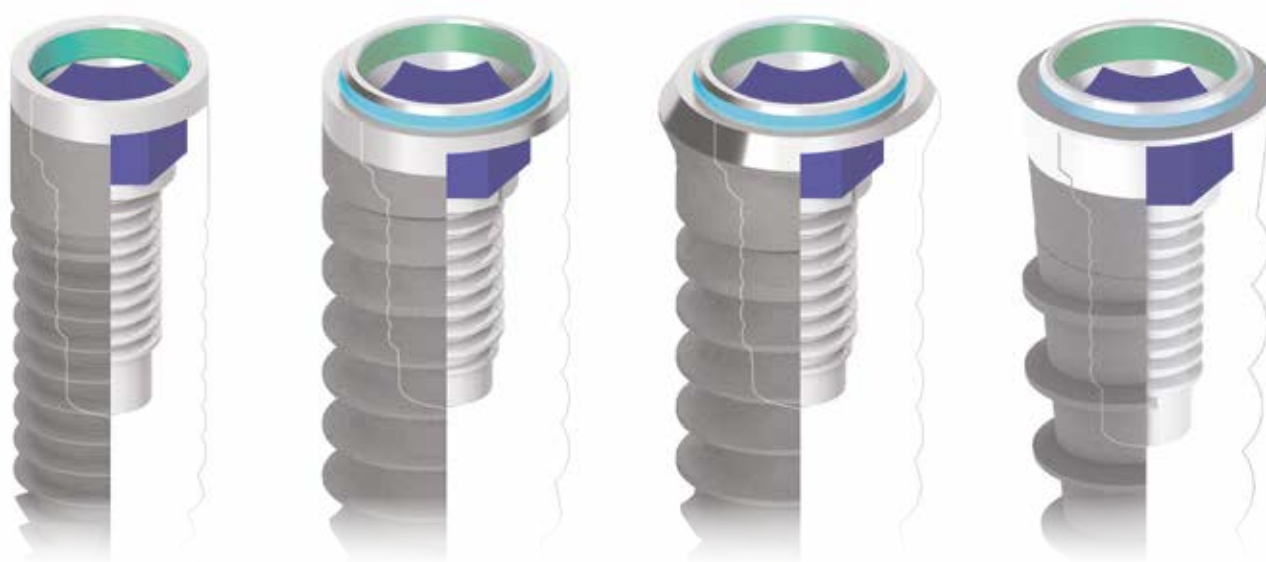

*COLLEX connection
Premium implants
Ø 3.30 mm*

*COLLEX connection
Premium Kohno Straight implants
Ø 3.80, 4.25, 5.00 mm*

*COLLEX connection
Premium Kohno SP implants
Ø 3.80, 4.25, 5.00 mm*

*COLLEX connection
Shelta implants
Ø 3.80, 4.25, 5.00 mm*

To document and quantify the benefits of the COLLEX connection, a comparative FEM analysis has been performed between a Premium implant and a virtual model with the same connection with an internal hexagon, but without the prosthetic support collar. The resistance values of the implant-prosthetic complex with the COLLEX connection were found to be 25% higher than the values obtained for the standard connection without collar.

(Covani U., Ricci M., Tonelli P., Barone A. – An evaluation of new designs in implant-abutment connections: a finite element method assessment – Implant Dentistry Volume 22, Number 3 2013).

Important warning

For the same implant diameters, implants with a Straight emergence profile and with a Platform Switching emergence profile use the same prosthetic components, and no distinctions will therefore be made between them in this manual.

Contracone seal

One of the key factors that determine the success of an implant-prosthetic rehabilitation is the absence of bacterial infiltration. To achieve this, there must be no spaces between the implant and abutment platforms that could permit the transit of bacteria, which migrating towards the implant could cause anaerobic proliferation with serious consequences for peri-implant tissues. Sweden & Martina has patented a special micromechanical production process that makes both surfaces resting against each other perfectly conical. This creates a mechanical barrier that guarantees a peripheral seal that can limit bacterial penetration and protect peri-implant tissues against possible inflammation.

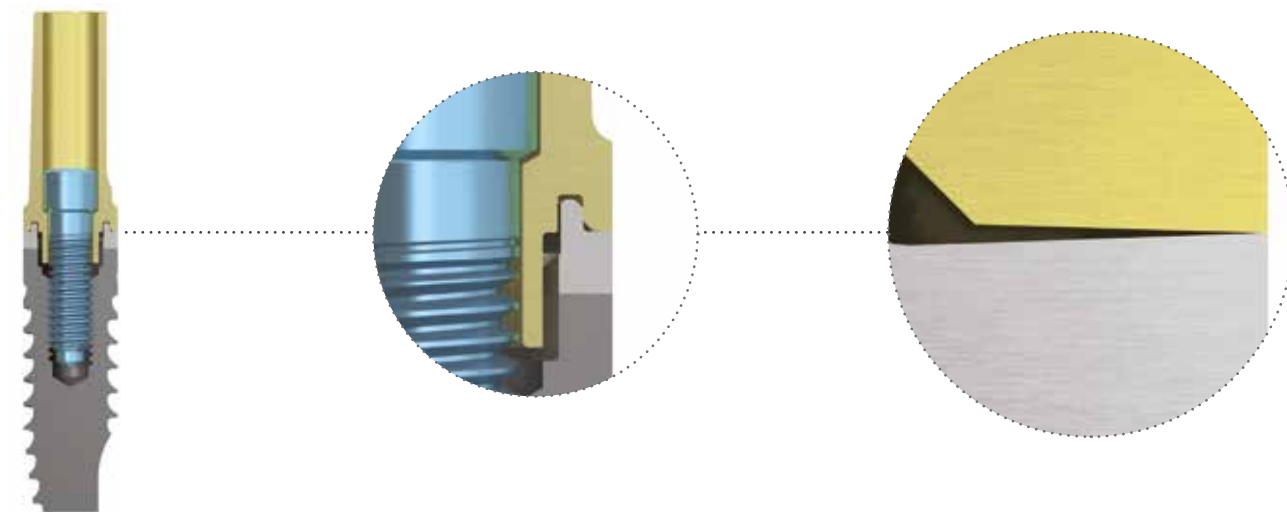

Important warning

The precision of this coupling is made possible only by a rigorous study of working tolerances, and the benefits of the CONTRACONE seal can therefore be obtained only by using original Sweden & Martina prosthetic components. The use of non-original products not only invalidates the CONTRACONE concept, but also creates the risk of generating significant gaps at the level of the connection.

Implant Platform Switching

The aim of the Platform Switching protocol, a prosthetic method amply validated by scientific literature, is to move the junction between the implant and the post away from the crestal bone. This result can be achieved either by improvising a broadened emergence at the level of the implant neck, or by using posts of a smaller diameter than the implant platform, where the geometry of the connection is the same for all sizes of the range. Premium Kohno SP implants were specifically developed to permit prosthetic rehabilitations using the Platform Switching protocol, with the bevel around the connection platform effectively moving the prosthetic junction further away both vertically and horizontally. The morphology of the implant neck also gives excellent primary stability. The Platform Switching technique used in these implants is called "Implant Platform Switching", as it is inherent in the morphology of the fixture.



*Ground section of a Premium Platform Switching implant at 4 months after insertion.
(Image by kind permission of Dr D. Botticelli).*



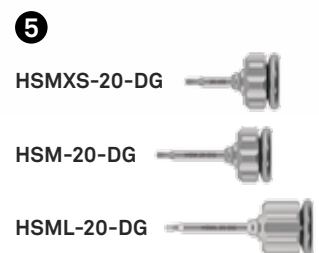
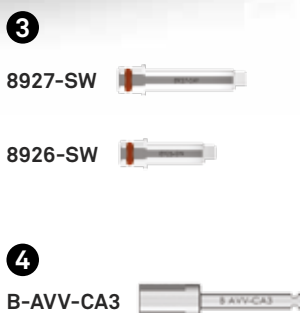
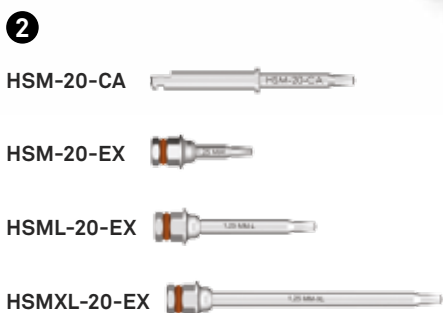
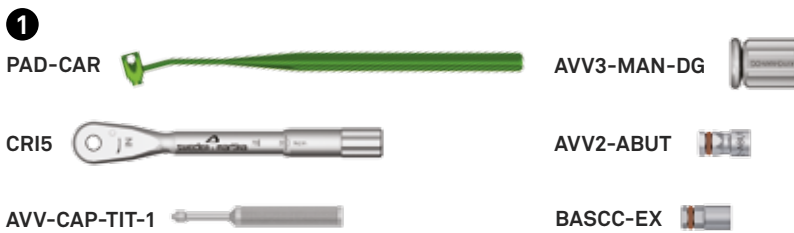

Screw Kit

The Sweden & Martina Screw Kit is a practical set containing the drivers necessary for the prosthetic phases of Premium, Kohno and Shelta implants, for the various prosthetic solutions: standard posts, abutments, P.A.D. prostheses, Locator abutments, ball abutments and their respective retention caps. In addition to manual and contra-angle handpiece drivers, Screw Kit also includes a carrier for transporting angled P.A.D. abutments, thus facilitating rapid full-arch prosthetic rehabilitations as well.

The kit includes manual and contra-angle handpiece drivers, together with a torque-control ratchet. Small and easily transportable, the kit makes it possible to manage the post-surgical prosthetic rehabilitation phase simply and rapidly.



NB: To guarantee the maximum duration of surgical instruments, it is advisable to follow the recommended cleaning and sterilization procedures.

description	code
Complete Screw Kit	ZSCREW* 
Instrument tray for Screw Kit	SCREW-TRAY* 
Kit with 5 spare silicone supports for surgical trays, for drills or instruments with shank for contra-angle handpiece	GROMMET-CA-1 
Kit with 5 spare silicone supports for surgical trays, for instruments with a hexagonal connection	GROMMET-CA-2 

* ZSCREW* and SCREW-TRAY* are followed by a letter and a number indicating the release version of the kit. The Screw Kit may be updated and varied in accordance with the most effective and innovative surgical techniques.

Important warning

Some of the instruments necessary for prosthetic protocols may also be included in surgical kits. Please consult the respective catalogues for details on the updated contents of these kits.

Drivers for connecting screws

All made of steel for surgical use. All drivers have the same tip design, and screwdrivers are therefore interchangeable. Drivers differ in their total length, with hex key of 1.25 mm, and can be one-piece manual models, with an incorporated knob for easy gripping, fitted with a hexagonal connector compatible with the ratchet or with shank for contra-angle handpiece. All drivers have a conical tip that allows connecting screws to be picked up and transported.

Regular checks must be made to ensure that this function has not been impaired due to wear on the tip.

Important warning

Excessive torque may strip the wells of the connecting screws and wear away the edges of screwdrivers, causing intraoperative or prosthetic complications that may even be serious. The recommended torque values for the tightening of the various components are summarized in this chart:

surgical screws, transgingival healing abutments	(manually) 8–10 Ncm
all prosthetic screws	20-25 Ncm
all prosthetic components screwed directly onto an implant	25-30 Ncm
transfer connecting screws	(manually) 8–10 Ncm

Given the importance of tightening torques, it is advisable to always use drivers with a hexagonal connector, controlling the torque applied using the ratchet, or with a contra-angle connection with a corresponding torque control driver. To facilitate the engagement of screws or other threaded parts of prosthetic components, screwing operations can however be started with manual drivers.

Driver for contra-angle handpiece

Both Screw Kits and surgical kits contain a driver with a shank for a contra-angle handpiece, an extremely practical accessory in both surgical and prosthetic phases when used with a micromotor with torque control, or a right angle manual driver with torque control. This driver can be used only to tighten posts with a screw hole no longer than 11.00 mm.

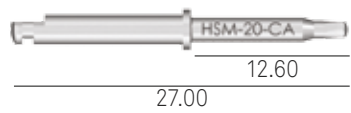
description	code
Driver with shank for contra-angle handpiece	<p>HSM-20-CA</p> 

Manual drivers

The design of manual drivers makes them extremely practical during surgery and when uncovering and handling transgingival healing abutments. Manual drivers must not be used when working with definitive prostheses, as they do not allow tightening torque to be controlled. Some of these drivers are also included in the surgical kits of the Premium, Kohno and Shelta systems. These manual drivers have a tapered tip that can fractionally grip small parts such as cover screws or healing abutments to prevent them from being dropped when transferring them to the patient. Please refer to the catalogues and surgical manuals of the single systems for full details. One-piece drivers of the following lengths are available in the Screw Kit.

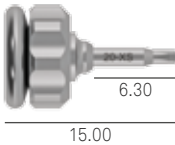
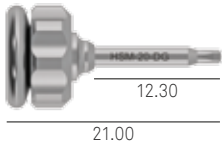
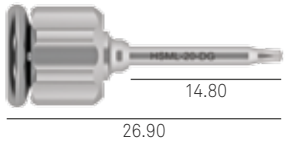
description	code
Extra-short manual driver for surgical cover screws and connecting screws	HSMXS-20-DG 
Short manual driver for surgical cover screws and connecting screws	HSM-20-DG 
Long manual driver for surgical cover screws and connecting screws	HSML-20-DG 

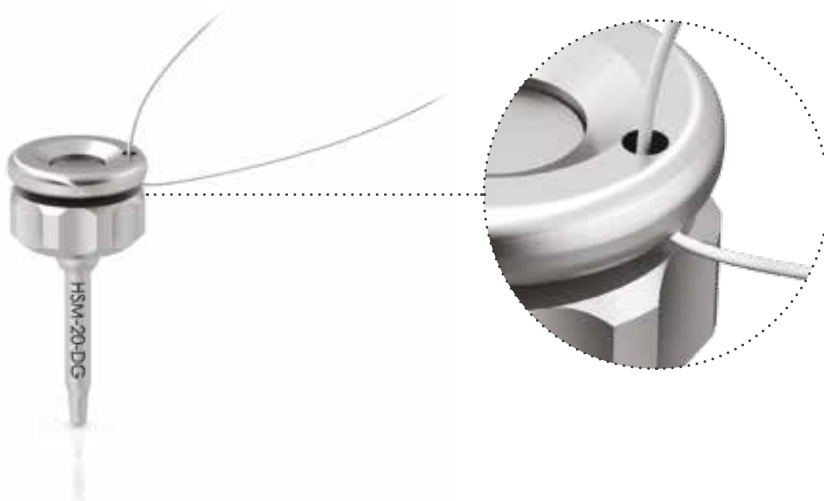

Important warning

It is advisable to pass a safety thread through the hole provided on the top of the knob to prevent it being dropped.

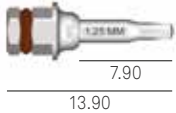
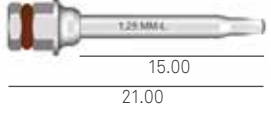
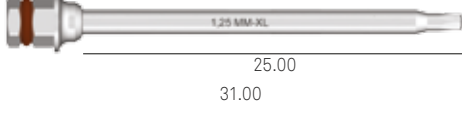

Drivers that can be used with the torque-control ratchet

Drivers with an upper hexagonal connector are designed for use with the torque-control ratchet to provide torque control. The Screw Kit includes short, long and extra-long versions, and this latter is for use when the screw hole inside posts is longer than 13.00 mm. Some of these drivers are also included in the surgical kits of the Premium, Kohno and Shelta systems. Please refer to the catalogues and surgical manuals of the single systems for full details.

description	code
Short driver with hexagonal connector for torque-control ratchet or manual knob	<p>HSM-20-EX</p> 
Long driver with hexagonal connector for torque-control ratchet or manual knob	<p>HSML-20-EX</p> 
Extra-long driver with connector for torque-control ratchet or manual connector	<p>HSMXL-20-EX</p> 
Driver for standard abutments and straight P.A.D. abutments, with hexagonal connector for torque-control ratchet	<p>AVV2-ABUT</p> 

Important warning



All drivers for use with a ratchet have a red polymer O-ring inside the connection hexagon, to ensure adequate grip for instruments and therefore the correct position of components. This O-ring must be checked periodically and replaced when worn or no longer able to ensure the correct grip.

A kit of 5 spare O-rings is available, with order code **ORING180-088**.

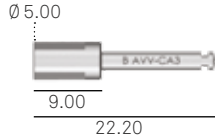

Other instruments

The following instruments are included in the Screw Kit or can be ordered separately. The first two are also included in various surgical kits of the Premium, Kohno and Shelta systems. Please refer to the catalogues and manuals of the single systems for full details.

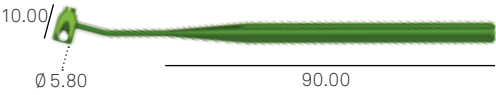
description	code
Adaptor with shank for contra-angle handpiece for instruments with a hexagonal connector	<p>B-AVV-CA3</p> 
Manual knob for drivers, hexagonal keys and manual drivers	<p>AVV3-MAN-DG</p> 
Carrier for transport of angled P.A.D. abutments into the oral cavity, sterilizable and reusable. Must be fixed to abutments with screw PAD-VTRAL-140	<p>PAD-CAR</p> 

The BPM-15 extension, which may be useful in some clinical situations, is not included in the Screw Kit, but can be ordered separately, and is included in the surgical kits of the Premium, Kohno and Shelta systems. Please refer to the catalogues and manuals of the single systems for full details.

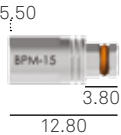
description	code
Extension for hexagonal keys, drivers and manual drivers, with hexagonal connector for torque-control ratchet	<p>BPM-15</p> 

All measurements are in mm, unless otherwise indicated.

CRI5-KIT torque-control ratchet

The surgical kit of the implant system includes a special ratchet (CRI5-KIT), together with an adjustment key that can be used to rapidly turn the torque adjustment sleeve, and a gel lubricant for maintenance. The ratchet can be used with torque regulations from 10 to 70 Ncm, or in a locked position without torque control. When using the prosthetic ratchet to tighten screws, reference must be made to the torque values indicated on page 96. The CRI5 ratchet is a multipurpose instrument that can be dismantled, and it is supplied as non-sterile.

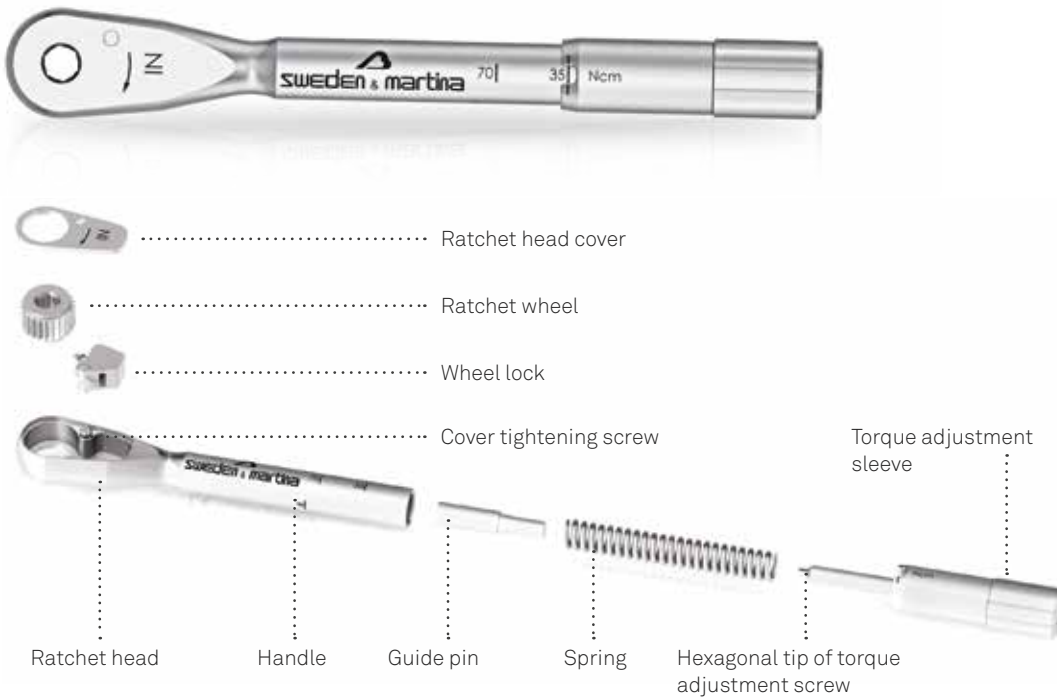

Every time this instrument is used, it must first be cleaned and sterilized, following the instructions on pages 98–99. Adequate maintenance, carried out scrupulously following all steps indicated for dismantling and reassembly of the instrument during cleaning operations, is essential for its correct use and to prolong its lifespan. Personnel using this instrument must be suitably trained, and must have read the instructions given in this manual before proceeding with any operations whatsoever with it. After sterilization, the ratchet is ready for use. It must be tested for correct assembly and operation every time it is used, whether for surgical procedures or for prosthetic procedures.

Torque is adjusted by aligning the marking for the desired torque in the circular opening of the handle. The “IN” arrow on the head when seen from above indicates the position of the ratchet that allows screws to be tightened. The “OUT” arrow on the head when seen from above indicates the position of the ratchet that allows screws to be loosened. A position of unlimited torque can be obtained by setting the torque adjustment device to the notch marked “R” on the ratchet handle.



The torque adjustment sleeve can be tightened and slackened manually, but these operations can be carried out more rapidly using the hexagonal key included in the kit, which allows it to be turned more quickly. The personnel responsible for the use and maintenance of this dental instrument must check it for possible signs of deterioration of the tightening, insertion and torque mechanisms. The single components of the ratchet are not interchangeable, and it is not possible to use a component from one ratchet to replace a component on another, because every ratchet is INDIVIDUALLY calibrated. If a component is lost, always return the entire instrument to Sweden & Martina for all necessary repairs. Components for the assembly of the ratchet are not sold individually. Failure to respect the instructions provided may cause maintenance problems and may also affect prosthesis stability.



Important warning

Torque is always adjusted by tightening/slackening the sleeve at the end of the instrument handle. Torque must always be adjusted upwards, starting from a value lower than that required and tightening the adjustment sleeve in a clockwise direction until the desired value is reached. This means that if a torque value lower than that used previously is to be set, the adjustment sleeve must be slackened by two whole turns beneath the new torque value required, and then tightened again in a clockwise direction to the desired value.



To adjust torque upwards, turn the adjustment sleeve in a clockwise direction.

To adjust torque downwards to a value lower than that used previously, turn the adjustment sleeve in an anticlockwise direction until it is two whole turns below the required value. Then tighten it in a clockwise direction until the desired torque value is reached.

Techniques for taking impressions and making models

The correct taking of impressions is the key to success in any implant-prosthetic treatment plan, because if information with as few errors as possible is sent to the laboratory, this makes it possible to save working time and above all to produce prostheses without internal stresses that do not exert undesired strain on implants.

Impressions can be taken at various moments of surgery, depending on protocols and/or habitual practice.

Impressions can be taken on all Sweden & Martina implants with three different protocols:

- closed tray with Pull-up transfer;
- open tray with Pick-up transfer;
- closed tray with closed-tray transfer.

Pull-up transfer: the connection with tabs snaps into the hexagonal implant connection, without needing to be screw retained.

Pick-up transfer: the design of the upper section guarantees excellent retention and therefore extremely stable fixation in the impression.



In addition to these possibilities, some prosthetic protocols with special components also envisage the transfer onto the laboratory model not of the implant connection, but instead of the intermediate prosthetic platforms, as in the case of P.A.D. abutments, standard abutments and PLAIN abutments. Consult the different protocols of use for the specific instructions on using these components.

Important warning

It is advisable to always use new transfers and analogues for all cases, so as to guarantee maximum coupling precision at the level of the connection. Transfers and analogues used more than once reciprocally deform the walls of the respective hexagons, transferring errors to impressions that can generate stresses in prostheses which are then transferred to implants and can compromise satisfactory clinical outcomes, above all in the case of multiple structures.

Analogues

Components for impressions and for the production of models are manufactured with the same machines used to make implants, ensuring the same high level of precision for tolerances and for the accurate reproduction of clinical situations. Analogues are anodized following a colour code, making it easier to recognize implant diameters and simplifying laboratory work.



connection	Ø 3.30 mm	Ø 3.80 mm	Ø 4.25 mm	Ø 5.00 mm	Ø 6.00 mm
Analogues in Grade 5 titanium	A-ANA-330	A-ANA-380	A-ANA-425	A-ANA-500	A-ANA-600

See page 85 for the technical characteristics of Grade 5 titanium.

All measurements are in mm, unless otherwise indicated.

Pull-up impressions

The Pull-up technique was developed by Sweden & Martina to make it easier to take impressions in cases in which the limited oral aperture of the patient makes it difficult to screw in and unscrew transfer screws.

Pull-up transfers are made completely in radiopaque PEEK. The connection is shaped in a way that allows them to be clicked into the inside of connection hexagons without needing to be fixed with a screw, but exploiting instead the stabilization capacity of the COLLEX connection. Quick and easy to use, they are extremely practical for taking positioning impressions, for example for the production of a model on which the individual tray can be developed. Also, being radiopaque, the correct insertion in the implant platform can be verified. They are extremely stable in the impression, thanks to the excellent retention offered by the upper section.

They can be used in combination with Pick-up transfers, for example in situations in which the mesial elements have sufficient space for screwing and unscrewing operations on the transfer screw, while the distal elements have anatomical difficulties.

They are the ideal solution for taking quick impressions between converging implants because they can be easily shortened by using a disk blade to remove one or more of the vertical modules, or to remove portions of horizontal retention arms that may cause interference.

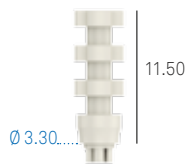
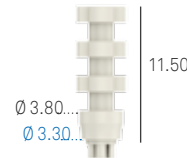
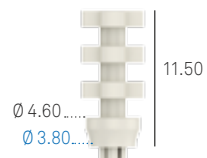
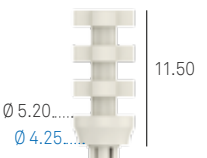
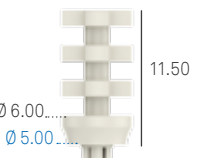

prosthetic component Ø	Ø 3.30 mm	Ø 3.80 mm	Ø 4.25 mm	Ø 5.00 mm
for implants	Premium 3.30 - 3.80 Kohno 3.80 Shelta 3.80	Premium 3.80 Kohno 3.80 Shelta 3.80 - 4.25 - 5.00	Premium 4.25 Kohno 4.25	Premium 5.00 Kohno 5.00 - 6.00
Pull-up transfer in radiopaque PEEK Straight emergence profile	A-TRAP-330 	-	-	-
Pull-up transfer in radiopaque PEEK Anatomical emergence profile	A-TRARP-330 	A-TRARP-380 	A-TRARP-425 	A-TRARP-500 

Important warning

Pull-up transfers are made in a polymer material. To guarantee precision, it is advisable to use new transfers for every impression taken.

See page 88 for the technical characteristics of PEEK.

All measurements are in mm, unless otherwise indicated.

Impression with Pull-up transfer

Expose the implant connections if a protocol with a double surgical phase has been used, or remove the transgingival healing abutments.



Position the Pull-up transfers and fix them by simply applying pressure with the hand, without needing to use instruments. The characteristic click of the transfer tabs indicates that the transfer has been correctly inserted in the implant connection.

Important warning

In case of poor visibility or doubts on complete coupling between the transfer and the implant, carry out a radiographic check. The PEEK polymer material used to make the transfers is radiopaque, and is therefore perfectly visible in X-rays.

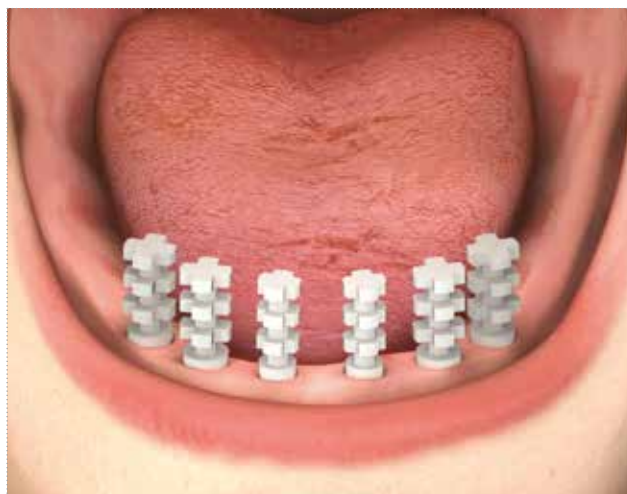

Position the tray and check that the entire height of the transfer is contained inside the walls of the impression tray.

Important warning

If necessary, the height of Pull-up transfers can be reduced by cutting away one or more modules with a disk blade. The retention of the remaining portion of the transfer in the impression material will be sufficient to ensure that the impression is taken correctly.



Inject a precision impression material (SKY IMPLANT LIGHT, code SKY14) only around the transfers, and at the same time fill the impression tray with a more consistent material (SKY IMPLANT ONEMIX-ED, code SKY08) along the entire arch. Then position the tray in place and wait for the hardening times as indicated by the instructions.

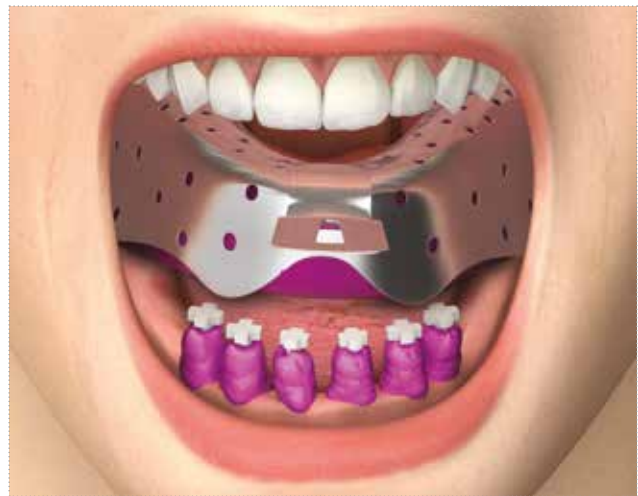

Lift the tray off vertically, and the Pull-up transfers will remain incorporated in the impression.

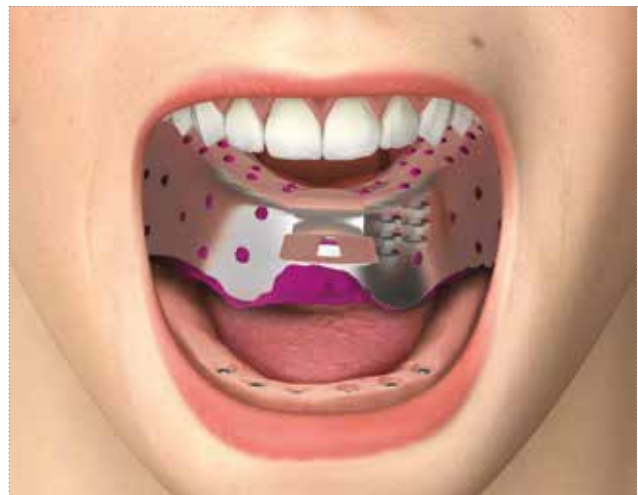









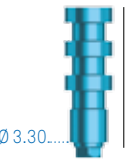

Couple each of the transfers with a laboratory analogue of a corresponding diameter. The characteristic click of the transfer tabs indicates that the analogue has been correctly inserted. Cast the preliminary model and create an individual impression tray using normal methods.

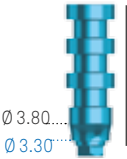
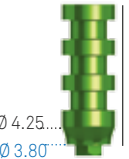

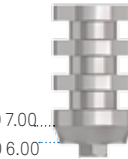
Open-tray impression and production of a model

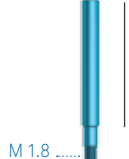
The open-tray impression requires the use of a personalized impression tray, made in a laboratory on a preliminary model with access apertures for the transfer screws at positions corresponding to the implants. It is advisable to use the short driver with a hexagonal connector for ratchet HSM-20-EX, or extra-short manual driver HSMXS-20-DG, both specifically developed to reduce the vertical space required and to facilitate screwing and unscrewing torque-control operations for the transfer screws in the oral cavity.

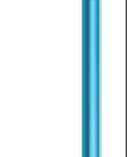
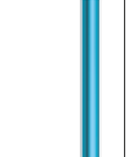
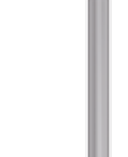
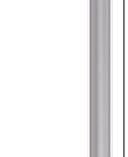
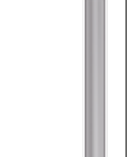

prosthetic component Ø	Ø 3.30 mm	Ø 3.80 mm	Ø 4.25 mm	Ø 5.00 mm	Ø 6.00 mm
for implants	Premium 3.30 - 3.80 Kohno 3.80 Shelta 3.80	Premium 3.80 Kohno 3.80 Shelta 3.80 - 4.25 - 5.00	Premium 4.25 Kohno 4.25	Premium 5.00 Kohno 5.00 - 6.00	Kohno 6.00
Pick-up transfer in Grade 5 titanium Straight emergence profile Connection screw included	A-TRA-330  Ø 3.30... 12.00	A-TRA-380  Ø 3.80... 12.00	-	-	-
Pick-up transfer in Grade 5 titanium Anatomical emergence profile Connection screw included	A-TRAR-330  Ø 3.80... Ø 3.30... 12.00	A-TRAR-380  Ø 4.25... Ø 3.80... 12.00	A-TRAR-425  Ø 5.20... Ø 4.25... 12.00	A-TRAR-500  Ø 6.00... Ø 5.00... 12.00	A-TRAR-600  Ø 7.00... Ø 6.00... 12.00
Connection screw for Pick-up transfer Supplied with transfers and also available separately as spares	VTRA2-180-15  M 1.8... 15.00	VTRA2-180-15  M 1.8... 15.00	VTRA2-200-15  M 2.0... 15.00	VTRA2-200-15  M 2.0... 15.00	VTRA2-200-15  M 2.0... 15.00
Long connection screw for Pick-up transfer Supplied with transfers and also available separately as spares	VTRA2-180-20  M 1.8... 20.00	VTRA2-180-20  M 1.8... 20.00	VTRA2-200-20  M 2.0... 20.00	VTRA2-200-20  M 2.0... 20.00	VTRA2-200-20  M 2.0... 20.00

Recommended torque for transfer screws: 8–10 Ncm manual.

See page 85 for the technical characteristics of Grade 5 titanium.

All measurements are in mm, unless otherwise indicated.

Impression with Pick-up transfer

Expose the implant connections if a protocol with a double surgical phase has been used, or remove the transgingival healing abutments.



Fix the Pick-up transfers with the specific screw supplied and the most suitable driver without exceeding a torque of 8–10 Ncm.

NB: The manual driver for surgical cover screws and connection screws is available with several shank lengths to cater for different clinical needs. A version with a hexagonal connector for a torque-control ratchet is also available, or with a shank for a contra-angle handpiece. See pages 18–19 for technical details on these drivers.

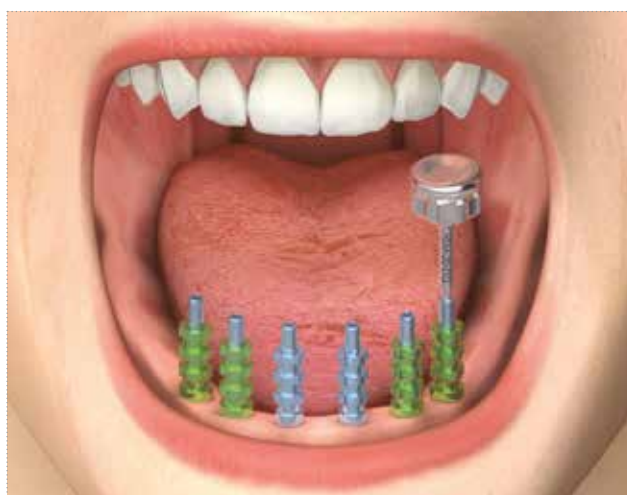

If desired, fix the transfers together with wire and resin, and wait for polymerization to be completed, as indicated by the manufacturer (e.g. SUN resin, code SUN-A2 or SUN-A3).

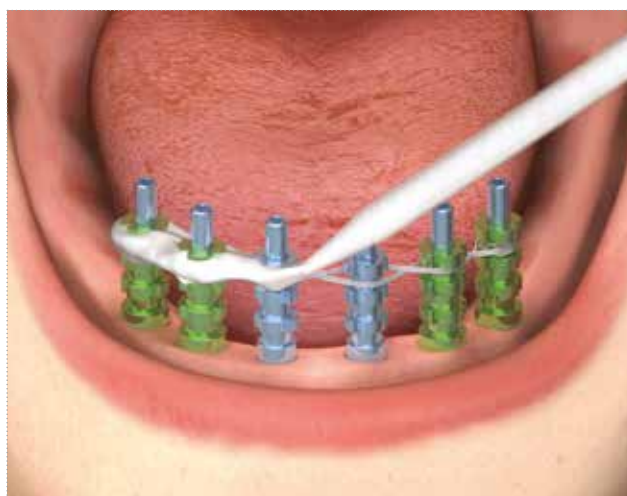

Check that the personalized tray, when placed in the mouth, contains the entire height of the transfer inside its walls, and that the summit of the transfer screw emerges for a suitable length from the respective hole in the tray. Inject a precision impression material (SKY IMPLANT LIGHT, code SKY14) only around the transfers and the fixing section and at the same time fill the impression tray with a more consistent material (SKY IMPLANT ONEMIX-ED, code SKY08) along the entire arch. Then position the tray in place and wait for the hardening times as indicated by the instructions.



Unscrew the transfer screws and remove them from the impression, to prevent them from accidentally falling into the patient's mouth when the impression tray is removed. Remove the tray. The Pick-up transfers remain incorporated in the impression.





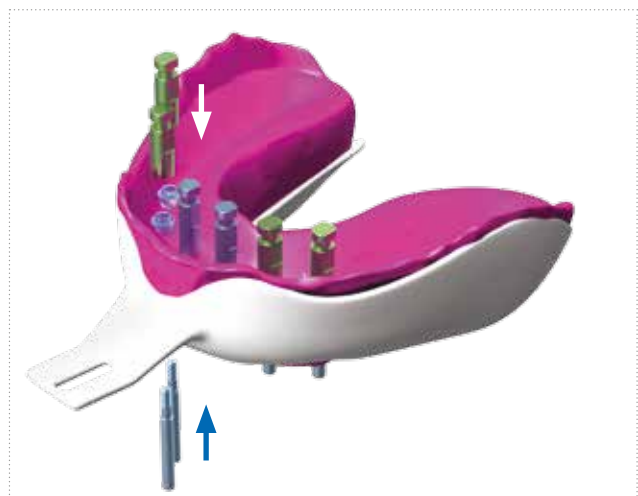



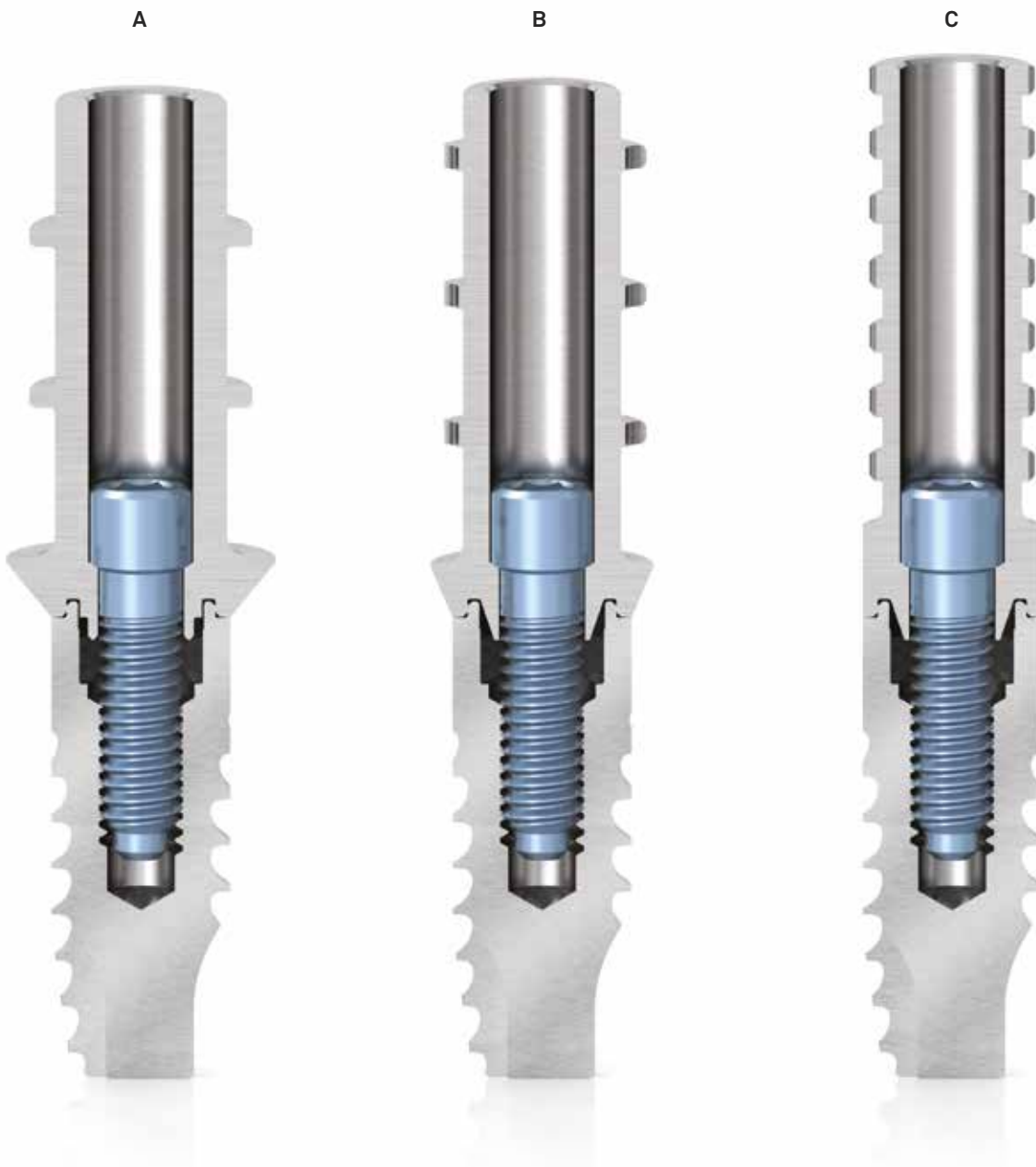

Screw the laboratory analogues of a corresponding diameter one by one onto the transfers using a transfer screw, repositioned in the hole left by each screw in the impression material. The recommended torque is 8–10 Ncm. Cast the model using normal methods.

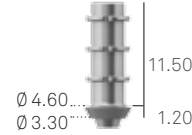
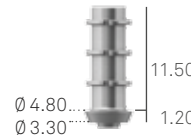
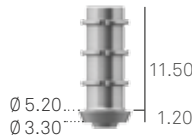
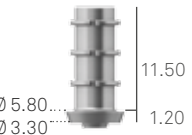
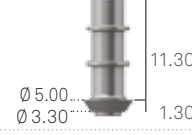
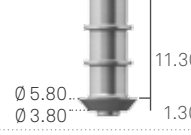
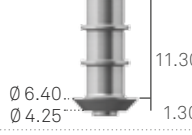
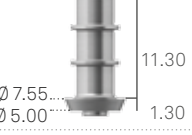

Total rehabilitations with Simple posts

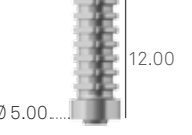
The Simple prosthetic protocol envisages practical and simple solutions for the production of screw-retained prostheses of both the Toronto Bridge type and the conventional Implant Bridge type, without aesthetic pink finishes, depending on the vertical height to be recovered. These prostheses can be used conventionally during the bone healing period, or immediately after the surgical insertion of implants, if the conditions for immediate loading are present. The versions with a wider transgingival profile, which can be adapted to any anatomy by milling, simplify the immediate aesthetic conditioning of the mucosae (**Fig. A**). The centring cone of Simple posts, without a repositioning hexagon, and a narrow transgingival profile make it significantly easier to create temporary multiple structures to be screwed directly onto implants, even in the presence of accentuated disparallelism (**Figs. B-C**).



prosthetic component Ø	Ø 3.30 mm	Ø 3.80 mm	Ø 4.25 mm	Ø 5.00 mm
for implants	Premium 3.30 - 3.80 Kohno 3.80 Shelta 3.80	Premium 3.80 Kohno 3.80 Shelta 3.80 - 4.25 - 5.00	Premium 4.25 Kohno 4.25	Premium 5.00 Kohno 5.00 - 6.00
SIMPLE temporary posts in Grade 5 titanium Non-repositionable Anatomical emergence profile Connection screw included	A-MPSA-330 	A-MPSA-380 	A-MPSA-425 	A-MPSA-500 
SIMPLE temporary aesthetic posts in Grade 5 titanium Non-repositionable Wide emergence profile Connection screw included	A-MPS-330 	A-MPS-380 	A-MPS-425 	A-MPS-500 
Temporary titanium posts Non-repositionable Connection screw included	A-MPSCI-330 	A-MPSCI-380 	A-MPSCI-425 	A-MPSCI-500 
Single pack Pack of 10 pieces Connection screw for posts Supplied with the temporary posts and also available separately as spares	VM2-180 VM2-180-10 	VM2-180 VM2-180-10 	VM2-200 VM2-200-10 	VM2-200 VM2-200-10 

See page 85 for the technical characteristics of Grade 5 titanium.

All measurements are in mm, unless otherwise indicated.

Simple Technique for the production of temporary resin prostheses

Prepare a diagnostic wax-up of the edentulous arch on the preliminary model, to functional and aesthetic aspects to be studied.

Reduce the height of the Simple posts in accordance with the vertical dimension defined by the wax-up. When working with preassembly on silicone masks, regulate the bite with a silicone rim.



Screw the Simple posts onto the implants just inserted and suture the flaps around them.

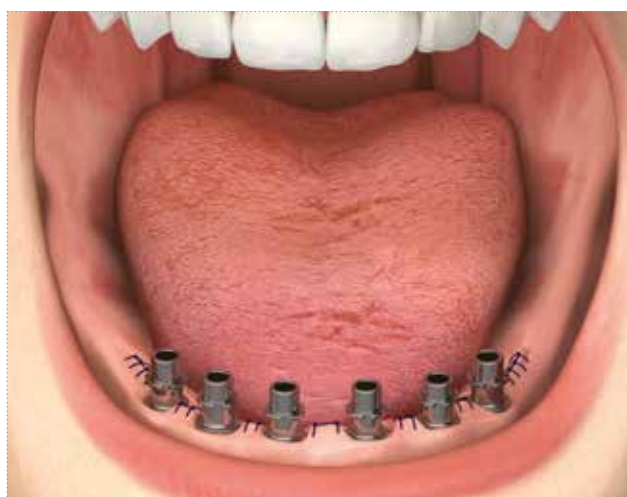

Fit a silicone dam around the bases of the Simple posts and fix them together with a self-polymerizing resin, so as to obtain a repositioning key. If preferred, the posts can also be fixed to a repositioning plate prefabricated in the laboratory.

Important warning

Take great care to scrupulously respect the resin hardening times indicated by the manufacturer, to avoid distortions and/or contractions after the removal of the repositioning key from the patient's mouth.



Determine the intermaxillary relationship between the upper arch and the Simple posts with a silicone rim.



Unscrew the Simple posts and fit the transgingival healing abutments until the temporary prosthesis is available.



Screw the respective implant analogues onto the Simple posts fixed together.



continues...

...continued

Insert the entire assembly into the intraoperative silicone bite block. Suitably positioned in the articulator, the block makes it possible to complete the lower model with the three-dimensional position of the implants.

NB: this procedure can be accomplished either by casting a new model starting from the repositioning key fitted into the articulator, or by using the single model method, using the preliminary model and repositioning the analogues screwed onto the repositioning key.



Incorporate the resin repositioning key in the diagnostic wax-up. In the case of a silicone mask, reposition the teeth used in preassembly inside their respective recesses, and pour the resin.



Transform the diagnostic wax-up into a temporary resin screw-retained aesthetic prosthesis on the Simple posts, using normal methods.

Important warning

It is advisable to suitably model and polish the emergence profiles of the Simple posts so as to obtain optimal conditioning of soft tissues during the healing phase.



Screw the temporary Simple prosthesis into the mouth, checking its passivation and the occlusal relationships. Preserve the screw heads and close the screw holes with a removable material, such as a composite or a resin.

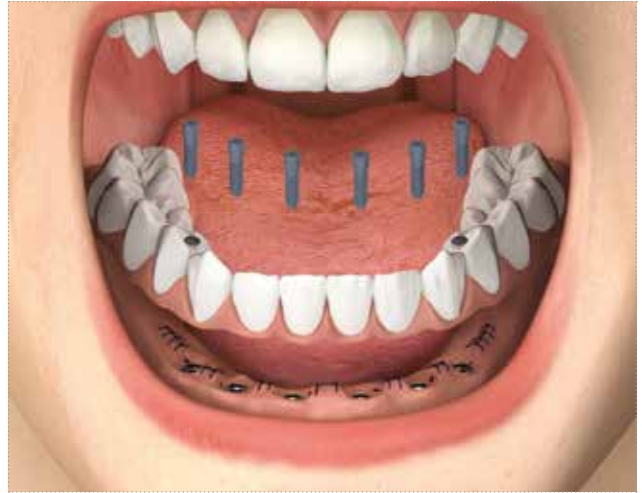

Simple technique for a reinforced structure

After taking the post-operative impression (see page 30) and while waiting for the prosthesis to be available, screw transgingival healing abutments onto the implants, choosing appropriate heights. (Consult the catalogue for every implant system for the available sizes.)



Screw the Simple titanium posts onto the model made previously using the specific HSM-20-DG driver (see pages 19–20) and the screw supplied.



Reduce the Simple posts to a size compatible with the patient's vertical dimension, using the silicone mask obtained from a preassembly or by placing the structure in an articulator in relationship to the space left by the antagonist.



Model the prosthesis reinforcement structure with wax or resin using normal methods, and perforate it at the positions of the Simple posts.



Proceed with the production of the metallic structure using normal methods. Test the structure on the model to check its complete passivity and correct perforation for the Simple posts. Complete the pink and white aesthetic effect of the prosthesis.



Screw the Simple posts into the mouth, respecting the positions defined by the laboratory. Test the temporary prosthesis, checking its passivation and occlusal relationships, and proceed with definitive cementation. Trim the base of the temporary prosthesis and screw it back into the patient's mouth, using a tightening torque of 20–25 Ncm. Close the screw holes with a material that can be removed by the operator.

Important warning

It is advisable to always use test screws for laboratory work, keeping the new screws supplied for definitive fixing in the patient's mouth.



Total rehabilitations with totally castable posts or with castable posts with metal base

Sweden & Martina produces posts of various types with a castable section, suitable for the production of screw-retained prosthesis solutions of both the Toronto Bridge type and the conventional Implant Bridge type, without aesthetic pink finishes, depending on the vertical height to be recovered:





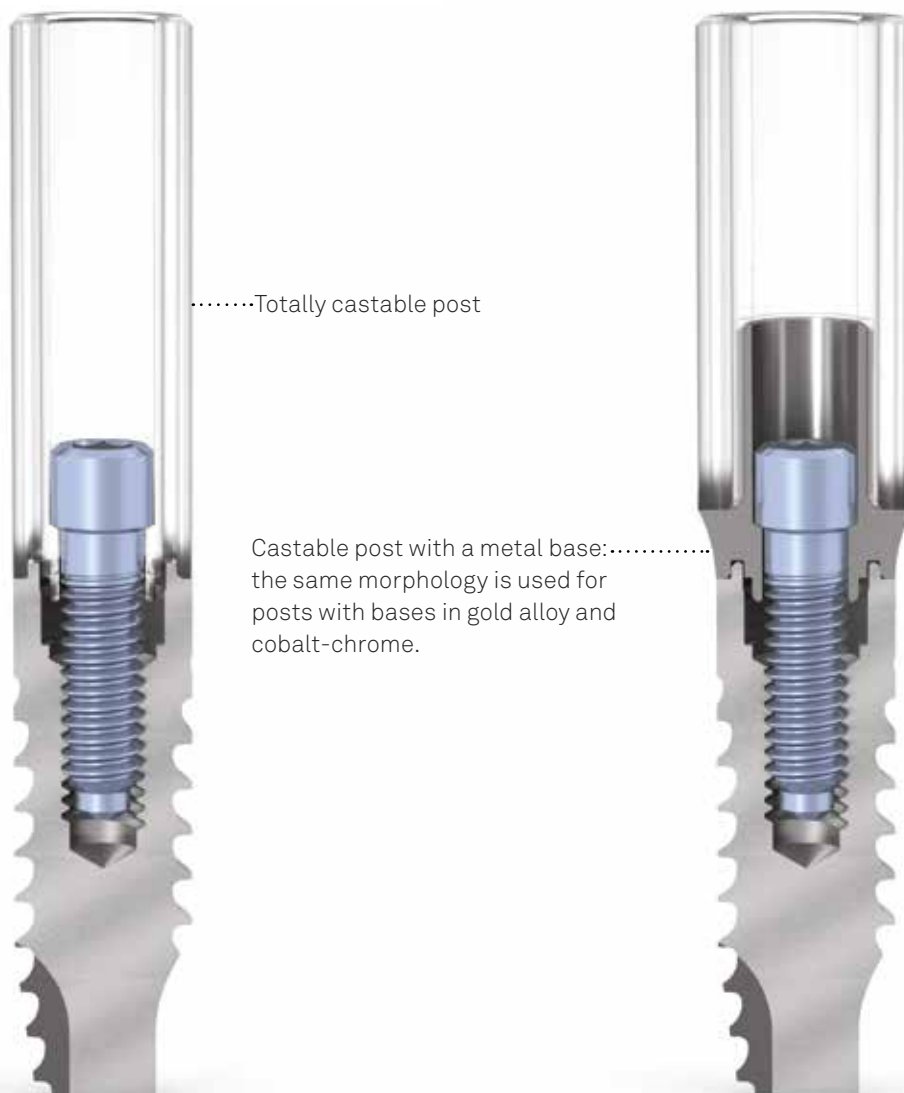





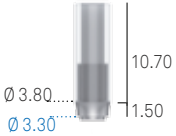
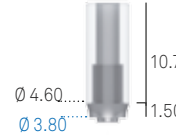
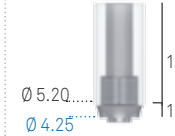



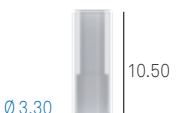

- castable posts in PMMA with gold alloy base for overcasting;
- castable posts in PMMA with titanium base;
- castable posts in PMMA with cobalt-chrome base for overcasting with cobalt-chrome, stellite alloy, base alloys (for information of casting with base alloys see page 91);
- totally castable posts in PMMA.

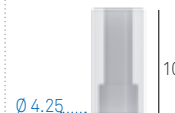
Castable posts in PMMA with a metal base allow overcasting bars to be produced while maintaining the precision of the connections, obtained using the same machining technologies as other prosthetic components. The recommended tightening torque for posts obtained after casting or overcasting is 20–25 Ncm. Posts are available complete with their respective fixing screws, which can also be ordered separately as spares. See page 86 for the technical characteristics of the various alloys and PMMA. Totally castable posts (codes A-CC-** and A-CCR-**) are also available, made using machining technologies and not by pressing. It must however be remembered that casting may cause deformations that may compromise the precision of the coupling between the implant interface and the prosthesis interface at the level of the connection platform.

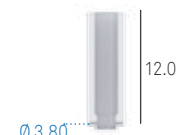
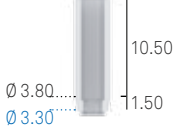
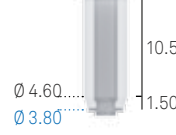
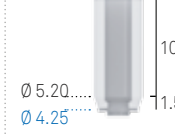
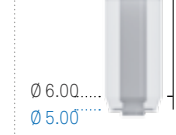

.....Totally castable post

Castable post with a metal base:.....
the same morphology is used for posts with bases in gold alloy and cobalt-chrome.

prosthetic component Ø	Ø 3.30 mm	Ø 3.80 mm	Ø 4.25 mm	Ø 5.00 mm	Ø 6.00 mm
for implants	Premium 3.30 - 3.80 Kohno 3.80 Shelta 3.80	Premium 3.80 Kohno 3.80 Shelta 3.80 - 4.25 - 5.00	Premium 4.25 Kohno 4.25	Premium 5.00 Kohno 5.00 - 6.00	Kohno 6.00
Castable posts with preformed base in gold alloy 1 Non-repositionable Anatomical emergence profile Connection screw included	A-UCR-330 	A-UCR-380 	A-UCR-425 	A-UCR-500 	Use A-UCR-500
Castable posts with preformed base in cobalt-chrome Non-repositionable Anatomical emergence profile Connection screw included	A-UCRCO-330 	A-UCRCO-380 	A-UCRCO-425 	A-UCRCO-500 	Use A-UCRCO-500
Spare castable sleeves for castable posts with alloy base Without connection screw	A-CCUCR-330 	A-CCUCR-380 	A-CCUCR-425 	A-CCUCR-500 	Use A-CCUCR-500
Totally castable posts Non-repositionable Straight emergence profile Connection screw included	A-CC-330 	A-CC-380 	-	-	-
Totally castable posts Non-repositionable Anatomical emergence profile Connection screw included	A-CCR-330 	A-CCR-380 	A-CCR-425 	A-CCR-500 	A-CCR-600 
Single pack Pack of 10 pieces Connection screw for posts Supplied with the posts and also available separately as spares	VM2-180 VM2-180-10 	VM2-180 VM2-180-10 	VM2-200 VM2-200-10 	VM2-200 VM2-200-10 	Utilizzare VM2-200

See page 86 and following pages for the technical characteristics of PMMA, titanium, gold alloy and cobalt-chrome.
Recommended torque for definitive fixing of connecting screws: 20–25 Ncm.
If totally castable posts are used during laboratory work, tightening torque must not exceed 8–10 Ncm.

Important warning

It is advisable to always use test screws for laboratory work, keeping the new screws supplied for definitive fixing in the patient's mouth.

Production of a prosthesis with a reinforced structure

NB: The same procedure illustrated in the following images using castable posts with a metal base is also applicable when totally castable sleeves are used. When using totally castable sleeves, great care must be taken to avoid tightening posts on models with a torque exceeding 8–10 Ncm before casting.

Remove the temporary prosthesis from the patient's mouth and take a precision impression (see page 26 and following pages). Replace the temporary prosthesis. After making the model, screw the posts onto the analogues using the HSM-20-DG driver (see pages 19–20).

Important warning

During laboratory work, always use spare screws, available in single packs with codes VM2-180 for posts with 3.30 and 3.80 mm connections, and VM2-200 for 4.25, 5.00 and 6.00 mm connections. The same spare screws are also available in packs of 10 pieces, with codes VM2-180-10 and VM2-200-10. Use the definitive screws only for final tightening in the patient's mouth.



Adapt the castable sleeves to fit the patient's vertical dimension, using a silicone mask obtained from a pre-assembly, or by placing the structure in an articulator in relationship to the space left by the antagonist.



Model the castable structure, which will allow the metal framework of the final prosthesis to be obtained.



Create the structure using the standard protocol. Test the structure first on the model and then in the patient's mouth, checking for its complete passivity.

Important warning

If the structure is not completely passive, any stresses detected can be corrected by cutting the structure at one or more points, and rewelding it in the correct position.



Ceramize the final prosthesis using normal methods.





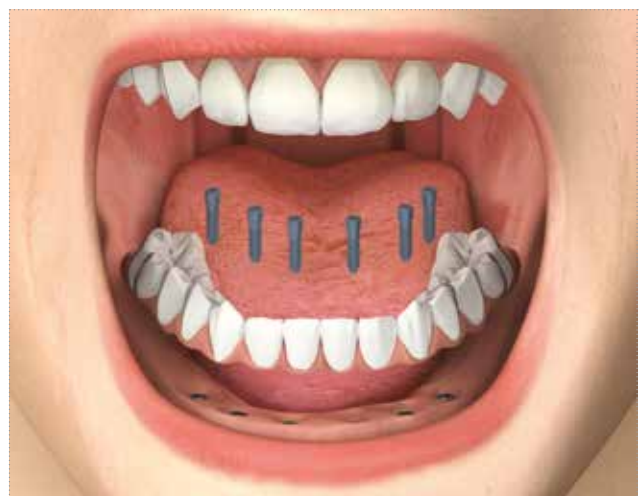





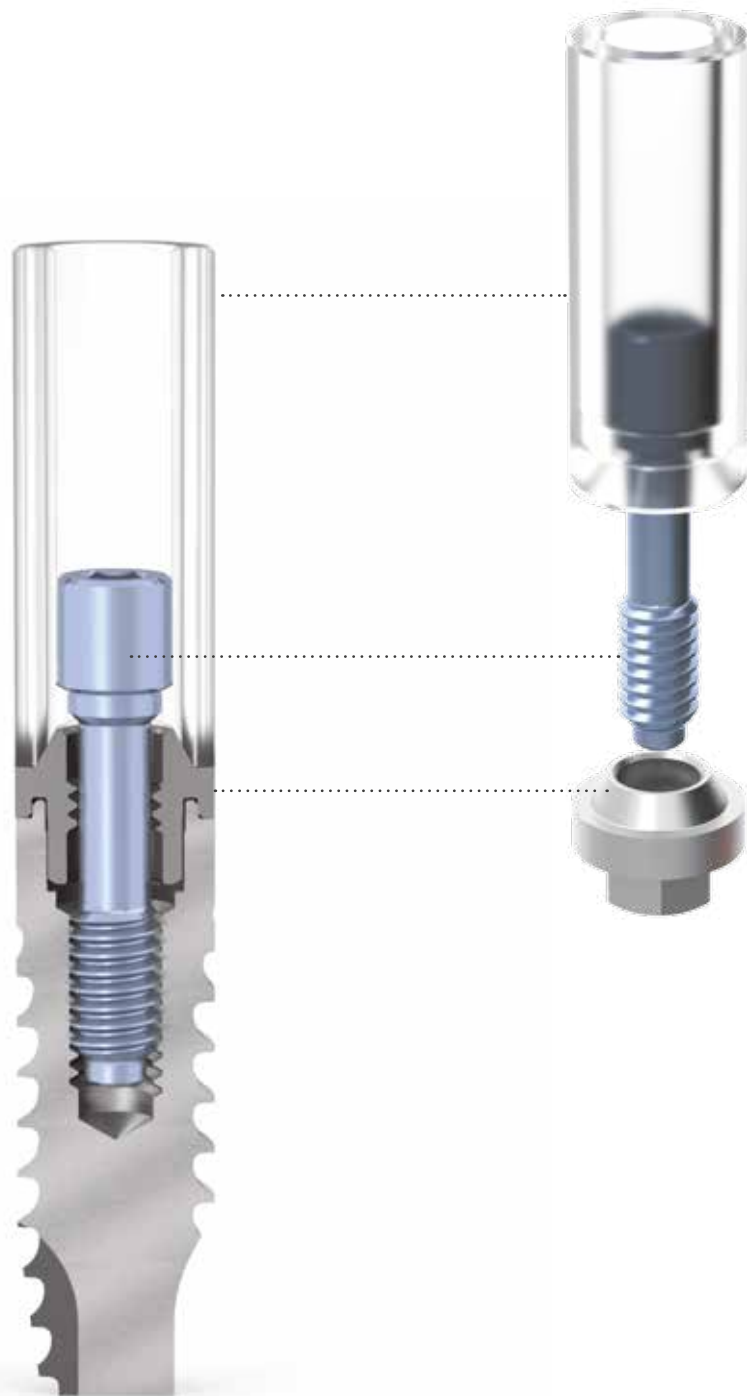

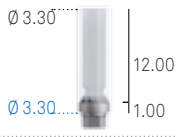
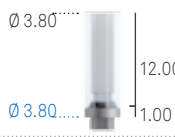
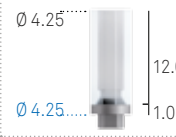



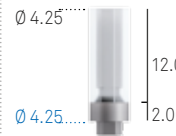

Screw the structure onto the implants, tightening the screws with a torque of 20–25 Ncm and checking it for passivation and occlusal relationships. Preserve the screw heads and close the screw holes with a removable material, such as a composite or a resin.



Total rehabilitations with intermediate abutments

These abutments have a straight emergence profile, and are composed of a repositionable base in Grade 5 titanium with a small upper cone with a height of 0.70 mm, which is the same for all connection diameters, allowing over-structures to be easily fitted and removed even in cases of slight disparallelism. Abutments are supplied complete with the castable sleeves to be used for modelling and casting the over-structure, and a through screw used to tighten the over-structure and abutments onto implants.



prosthetic component Ø	Ø 3.30 mm	Ø 3.80 mm	Ø 4.25 mm	Ø 5.00 mm	Ø 6.00 mm
for implants	Premium 3.30 - 3.80 Kohno 3.80 Shelta 3.80	Premium 3.80 Kohno 3.80 Shelta 3.80 - 4.25 - 5.00	Premium 4.25 Kohno 4.25	Premium 5.00 Kohno 5.00 - 6.00	Kohno 6.00
Straight abutments with through screw Repositionable Transgingival height 1 mm Connection screw included	A-ABU-330-1 	A-ABU-380-1 	A-ABU-425-1 	A-ABU-500-1 	A-ABU-600-1 
Straight abutments with through screw Repositionable Transgingival height 2 mm Connection screw included	A-ABU-330-2 	A-ABU-380-2 	A-ABU-425-2 	A-ABU-500-2 	A-ABU-600-2 
Connection screw for abutments Supplied with the abutments and also available separately as spares	A-VABU-180 	A-VABU-180 	A-VABU-200 	A-VABU-200 	A-VABU-200 
Spare castable sleeves for abutments Connection screw not included	A-CCABU-330-ROT 	A-CCABU-380-ROT 	A-CCABU-425-ROT 	A-CCABU-500-ROT 	A-CCABU-600-ROT 

See page 85 and the following pages for the technical characteristics of Grade 5 titanium and PMMA.
Recommended torque for connecting screws and transfer screws: 20–25 Ncm.

Important warning

It is advisable to always use test screws for laboratory work, keeping the new screws supplied for definitive fixing in the patient's mouth.

All measurements are in mm, unless otherwise indicated.

Production of a prosthesis with a reinforced structure

Take an impression as indicated on pages 24–33, and make the model using the standard procedure. Screw the abutments onto the analogues using the HSM-20-DG driver (see pages 19–20).

The definitive tightening torque for intermediate abutments is 20–25 Ncm. The prosthetic screw will secure the sleeve and the abutment to the analogue.

Important warning

During laboratory work, always use spare screws, available in single packs with codes A-VABU-180 for abutments with 3.30 and 3.80 mm connections, and A-VABU-200 for 4.25, 5.00 and 6.00 mm connections. Use the definitive screws only for final tightening in the patient's mouth.



Reduce the castable sleeves to a size compatible with the patient's vertical dimension, using the silicone mask obtained from a preassembly or by placing the structure in an articulator in relationship to the space left by the antagonist.



Model the castable structure, which will constitute the metal framework of the final prosthesis.



Cast the structure using normal methods. Test the structure first on the model and then in the patient's mouth, checking for its complete passivity.

The recommended torque for tightening all over-structures obtained by casting is 20–25 Ncm.

Important warning

If the structure is not completely passive, any stresses detected can be corrected by cutting the structure at one or more points, and rewelding it in the correct position.



Ceramize the final prosthesis using normal methods. Remove the over-structure and the intermediate abutments beneath it from the model.



Rest the abutments on the implants, engaging the hexagon in the connection, and then screw on the over-structure with a torque of 20–25 Ncm, checking for passivation and occlusal relationships. It is advisable to always use new screws to tighten the prosthesis in the patient's mouth. Preserve the screw heads and close the screw holes with a removable material, such as a composite or a resin.

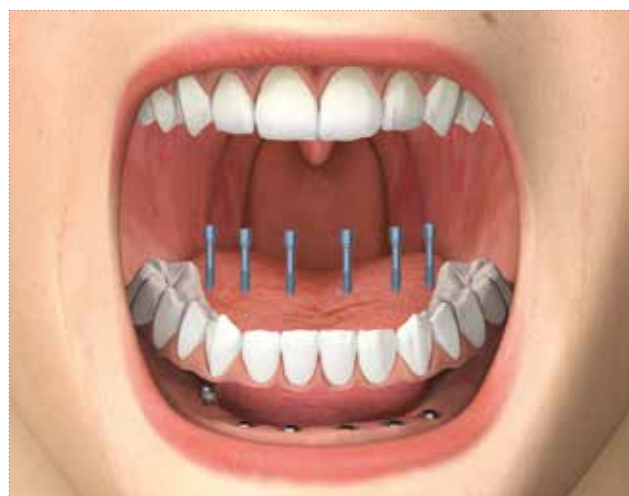

Total rehabilitations with Plain abutments

The special feature of these abutments, which are screwed directly onto implants, is that they exploit the completely flat geometry of the upper section, which is coupled to the special castable sleeves by means of a small guide.

The advantage of these abutments is therefore that they maximize centring and repositioning operations with structures screwed onto multiple implants.

PLAIN abutments are transported into the oral cavity, screwed in and tightened using the standard screwdrivers (code HSM-20-EX and HSML-20-EX for use with a torque-control ratchet wrench) included in the Premium, Kohno, Premium Kohno and Shelta surgical kits (see pages 18-20 for details on the items available).

The envisaged insertion torque is 25–30 Ncm to screw the abutment to the implant, and 20–25 Ncm to tighten the prosthetic screw.

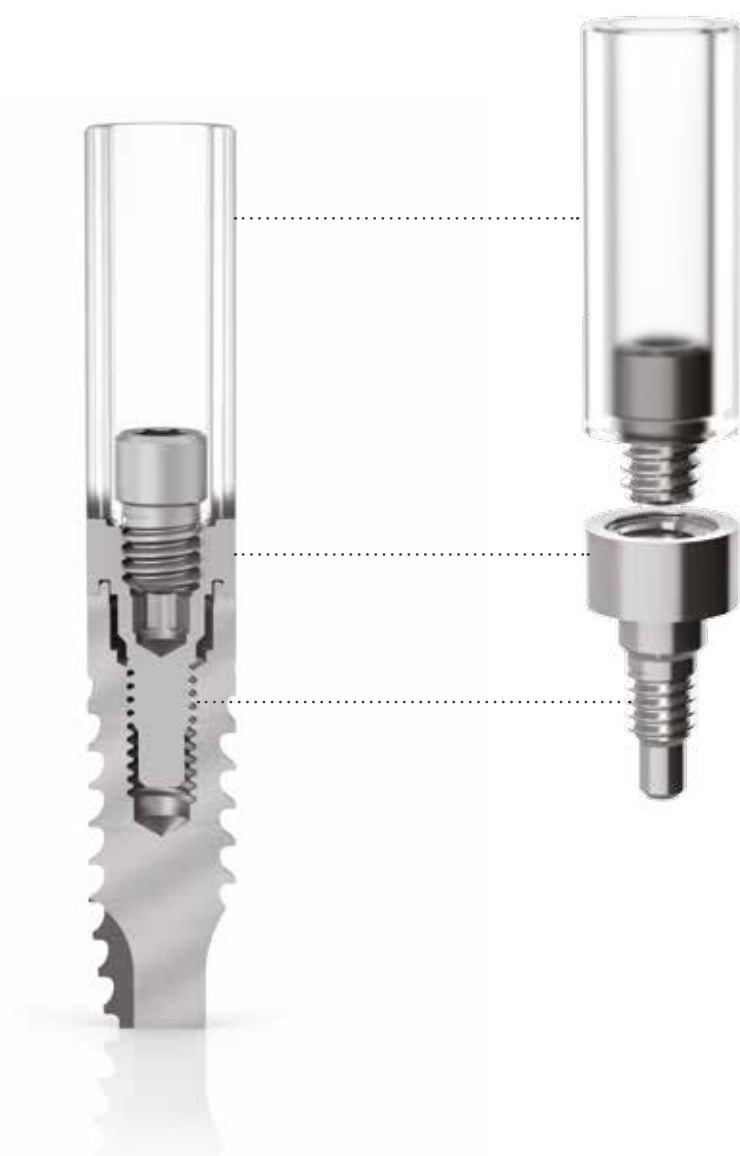



























Important warning

PLAIN abutments are available in single packs without a castable sleeve and the respective fixing screw, which must therefore be ordered separately.

Important warning

It is advisable to always use test screws for laboratory work, keeping the new screws supplied for definitive fixing in the patient's mouth.

prosthetic component Ø	Ø 3.30 mm	Ø 3.80 mm	Ø 4.25 mm	Ø 5.00 mm
for implants	Premium 3.30 - 3.80 Kohno 3.80 Shelta 3.80	Premium 3.80 Kohno 3.80 Shelta 3.80 - 4.25 - 5.00	Premium 4.25 Kohno 4.25	Premium 5.00 Kohno 5.00 - 6.00
PLAIN abutment for direct screwing in Grade 5 titanium Transgingival height 2 mm	A-PLAIN-ABU330-2 	A-PLAIN-ABU380-2 	A-PLAIN-ABU425-2 	A-PLAIN-ABU500-2 
PLAIN abutment for direct screwing in Grade 5 titanium Transgingival height 3 mm	A-PLAIN-ABU330-3 	A-PLAIN-ABU380-3 	A-PLAIN-ABU425-3 	A-PLAIN-ABU500-3 
PLAIN abutment for direct screwing in Grade 5 titanium Transgingival height 4 mm	A-PLAIN-ABU330-4 	A-PLAIN-ABU380-4 	A-PLAIN-ABU425-4 	A-PLAIN-ABU500-4 
Healing cap for PLAIN abutment in Grade 5 titanium	A-PLAIN-CG330 Ø 4.90... Ø 3.30... 	A-PLAIN-CG380 Ø 5.35... Ø 3.80... 	A-PLAIN-CG425 Ø 5.75... Ø 4.25... 	A-PLAIN-CG500 Ø 6.50... Ø 5.00... 
Castable sleeve in PMMA for PLAIN abutment Connection screw included	A-PLAIN-CC330 	A-PLAIN-CC380 	A-PLAIN-CC425 	A-PLAIN-CC500 
Single pack Pack of 10 pieces Connection screw for PLAIN abutment castable sleeve Supplied with sleeves and also available separately as spares	A-PLAIN-VP200 A-PLAIN-VP200-10 	A-PLAIN-VP200 A-PLAIN-VP200-10 	A-PLAIN-VP200 A-PLAIN-VP200-10 	A-PLAIN-VP200 A-PLAIN-VP200-10 

description	code
PLAIN abutment analogue in Grade 5 titanium	A-PLAIN-ANA 
Transfer for PLAIN abutment in Grade 5 titanium Connection screw included	A-PLAIN-TRA 
Spare screw for PLAIN transfers in Grade 5 titanium. Supplied with transfers for PLAIN abutments and also available separately as spares	A-PLAIN-VTRA200 

See page 85 and the following pages for the technical characteristics of Grade 5 titanium and PMMA.
Recommended torque for connecting screws: 20–25 Ncm.
Recommended torque for abutments: 25–30 Ncm.
All measurements are in mm, unless otherwise indicated.

Immediate loading

After inserting the implants, screw in the Plain abutments using the specific HSM-20-DG driver (see pages 19–20). The tightening torque of Plain abutments onto implants is 25–30 Ncm.



Screw a A-PLAIN-TRA transfer onto every Plain abutment, using the specific screws provided and the HSM-20-DG driver. The tightening torque Plain transfers onto abutments is 8–10 Ncm.

If desired, fix the transfers together with wire and resin, and wait for polymerization to be completed, as indicated by the manufacturer (e.g. SUN resin, code SUN-A2 or SUN-A3).

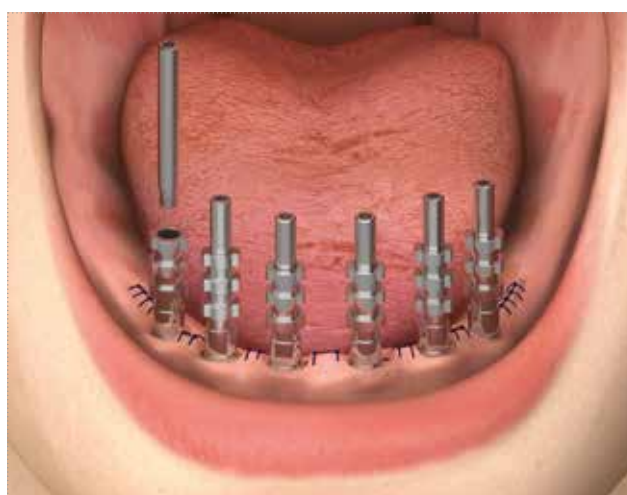

Check that the personalized tray, when placed in the mouth, contains the entire height of the transfer inside its walls, and that the summit of the transfer screw emerges for a suitable length from the respective hole in the tray. Inject a precision impression material (SKY IMPLANT LIGHT, code SKY14) only around the transfers and the fixing section and at the same time fill the impression tray with a more consistent material (SKY IMPLANT ONEMIX-ED, code SKY08) along the entire arch. Then position the tray in place and wait for the hardening times as indicated by the instructions.



Unscrew the transfer screws and remove them from the impression, to prevent them from accidentally falling into the patient's mouth when the impression tray is removed. Remove the tray. The Pick-up transfers remain incorporated in the impression.



Screw the specific titanium healing caps (A-PLAIN-CG***) onto the Plain abutments using the HSM-20-DG driver. The tightening torque for Plain healing caps on their respective abutments is 8–10 Ncm.



Screw the laboratory analogues (A-PLAIN-ANA) one by one onto the transfers using a transfer screw, repositioned in the hole left by each screw in the impression material. Fix the impression and cast the model using normal methods.



continues...

...continued

After taking the impression and making the model using standard procedures (see pages 24 to 33), screw the abutments onto the analogues using the specific HSM-20-DG driver. The definitive tightening torque for PLAIN abutments is 25–30 Ncm. Then fix all the A-PLAIN-CC* castable sleeves onto the Plain abutments using the A-PLAIN-VP200 connecting screws included in the pack for every sleeve. See page 86 for the technical characteristics of PMMA.

Important warning

During laboratory work, always use spare screws, available in single packs with code A-PLAINVP200 or in packs of 10 pieces with code A-PLAINVP200-10. Use the definitive screws only for final tightening in the patient's mouth.

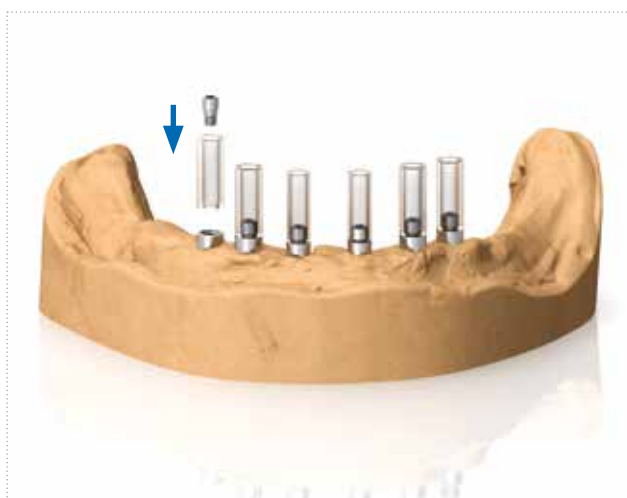

Reduce the castable sleeves to a size compatible with the patient's vertical dimension, using the silicone mask obtained from a preassembly or by placing the structure in an articulator in relationship to the space left by the antagonist.

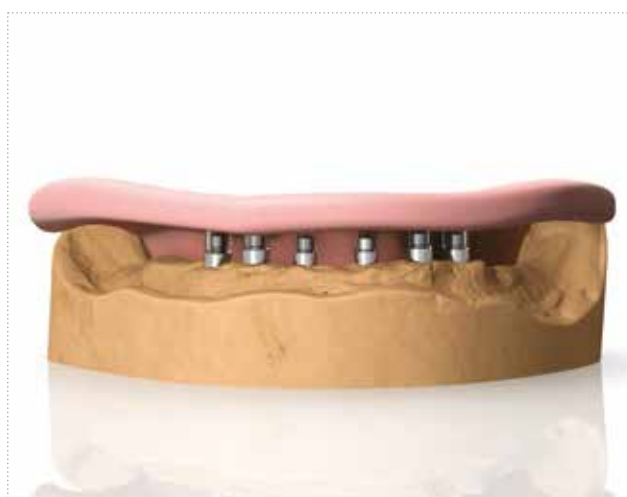

Make a castable structure, which will allow the metal framework of the final prosthesis to be obtained.



Create the structure using the standard protocol. Test the structure first on the model and then in the patient's mouth, checking for its complete passivity. The recommended torque for tightening all over-structures onto abutments is 20–25 Ncm.

Important warning

If the structure is not completely passive, even though the normal checking protocol has been followed, any stresses detected can be corrected if necessary by cutting the structure at one or more points, and rewelding it in the correct position.



Ceramize the final prosthesis using normal methods. Remove the over-structure and the PLAIN abutments beneath it from the model.



Unscrew the healing caps and screw the over-structure onto the abutments, using a torque of 20–25 Ncm. Check for passivation and occlusal relationships. It is advisable to always use new screws to tighten the prosthesis in the patient's mouth. Fill the screw holes with a material that can be removed by the operator.

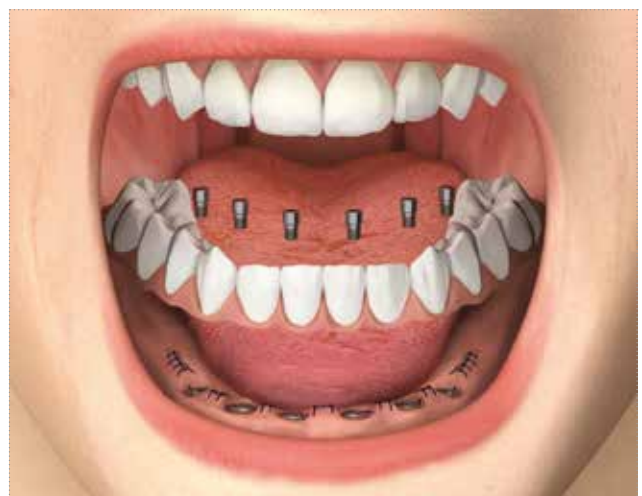

Total rehabilitations with disparallel screwed prosthesis (P.A.D. abutments)

The P.A.D. system was developed to facilitate the production of multiple screw-retained prostheses even in the presence of particularly divergent implants and disparallel prosthetic emergence axes, both with conventional techniques on 6 or 8 implants, and with All-on-Four* techniques. Straight P.A.D. abutments are supplied in non-sterile packs. Before being used clinically, titanium abutments must be sterilized in an autoclave. The AVV-ABUT-DG carrier is made in POM, and can therefore not be sterilized in an autoclave. The carrier must therefore be cold-sterilized before being used to transport an abutment into the patient's mouth. The different versions available, with angles of 17° and 30°, make the prosthetically favourable repositioning of connections possible even in case of particularly disparallel implants. This characteristic is enhanced by an additional 15° taper positioned above the P.A.D. platform, which further facilitates the insertion of multiple structures.

Angled P.A.D. abutments must be transported into the patient's mouth using the specific PAD-CAR transporter (see page 21) and a transfer screw, also made in titanium, to fix the abutment to the instrument. Before being used clinically, the components must be sterilized in an autoclave.



The upper taper allows the prosthetic structure to be oriented through 15° on each side, which in the case of angled P.A.D. abutments is added to the inclination of 17° or 30°. This characteristic allows disparallelisms of up to 45° to be easily managed.

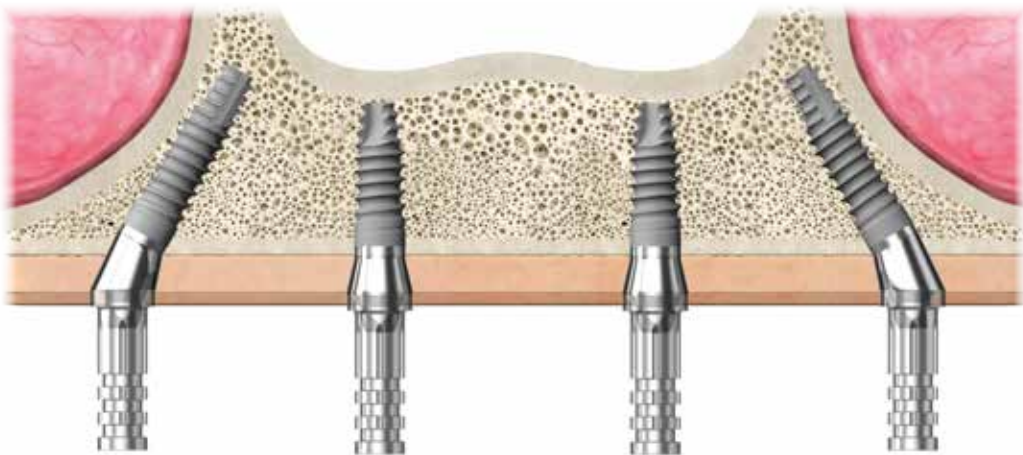

Straight P.A.D.s

prosthetic component Ø	Ø 3.30 mm	Ø 3.80 mm	Ø 4.25 mm	Ø 5.00 mm
for implants	Premium 3.30 - 3.80 Kohno 3.80 Shelta 3.80	Premium 3.80 Kohno 3.80 Shelta 3.80 - 4.25 - 5.00	Premium 4.25 Kohno 4.25	Premium 5.00 Kohno 5.00 - 6.00
Straight P.A.D. abutments in Grade 5 titanium For direct screwing Transgingival height 1.5 mm	A-PAD-AD330-15 	A-PAD-AD380-15 	A-PAD-AD425-15 	A-PAD-AD500-15
Straight P.A.D. abutments in Grade 5 titanium For direct screwing Transgingival height 3 mm	A-PAD-AD330-30 	A-PAD-AD380-30 	A-PAD-AD425-30 	A-PAD-AD500-30
Straight P.A.D. abutments in Grade 5 titanium For direct screwing Transgingival height 4 mm	A-PAD-AD330-40 	A-PAD-AD380-40 	A-PAD-AD425-40 	A-PAD-AD500-40

description	code
Driver for standard abutments and straight P.A.D. abutments, with hexagonal connector for torque-control ratchet	AVV2-ABUT

Important warning

All drivers for use with a ratchet have a red polymer O-ring inside the connection hexagon, to ensure adequate grip for instruments and therefore the correct position of components. This O-ring must be checked periodically and replaced when worn or no longer able to ensure the correct grip.

A kit of 5 spare O-rings is available, with order code **ORING180-088**.



See page 85 for the technical characteristics of Grade 5 titanium.

Angled P.A.D.s

prosthetic component Ø	Ø 3.30 mm	Ø 3.80 mm	Ø 4.25 mm	Ø 5.00 mm
for implants	Premium 3.30 - 3.80 Kohno 3.80 Shelta 3.80	Premium 3.80 Kohno 3.80 Shelta 3.80 - 4.25 - 5.00	Premium 4.25 Kohno 4.25	Premium 5.00 Kohno 5.00 - 6.00
P.A.D. abutment in Grade 5 titanium angled at 17° Transgingival height 3 mm Connection screw included	A-PAD-AA330-173 	A-PAD-AA380-173 	A-PAD-AA425-173 	A-PAD-AA500-173
P.A.D. abutment in Grade 5 titanium angled at 17° Transgingival height 5 mm Connection screw included	A-PAD-AA330-175 	A-PAD-AA380-175 	A-PAD-AA425-175 	A-PAD-AA500-175
P.A.D. abutment in Grade 5 titanium angled at 30° Transgingival height 3 mm Connection screw included	A-PAD-AA330-303 	A-PAD-AA380-303 	A-PAD-AA425-303 	A-PAD-AA500-303
P.A.D. abutment in Grade 5 titanium angled at 30° Transgingival height 5 mm Connection screw included	A-PAD-AA330-305 	A-PAD-AA380-305 	A-PAD-AA425-305 	A-PAD-AA500-305
Single pack Pack of 10 pieces Connection screw for posts. Supplied with the temporary posts and also available separately as spares	PAD-VM-180 PAD-VM-180-10 	PAD-VM-180 PAD-VM-180-10 	PAD-VM-200 PAD-VM-200-10 	PAD-VM-200 PAD-VM-200-10

description	code
Carrier to transport angled abutments into the oral cavity, sterilizable and reusable. (Not included in the surgical kit but included in the Screw Kit, and also available separately).	PAD-CAR

Recommended torque for connecting screws: 20–25 Ncm.

NB: to transport abutments into the oral cavity, every single pack contains a practical plastic carrier (code AVV-ABUT-DG, not available individually).







Important warning







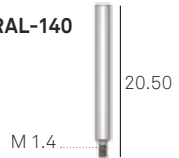
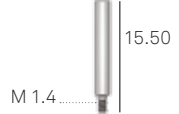
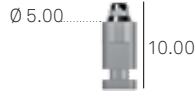

It is advisable to always use test screws for laboratory work, keeping the new screws supplied for definitive fixing in the patient's mouth.

See page 85 for the technical characteristics of Grade 5 titanium.

All measurements are in mm, unless otherwise indicated.

P.A.D. components for over-structures

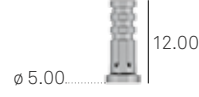
description	code
<p>Healing cap for P.A.D. abutments in Grade 5 titanium, to be used if abutments are not fitted immediately with a temporary prosthesis. Connection screw included (code PAD-VP-140), and also available as a spare part, to be tightened with a torque of 8–10 Ncm.</p>	<p>PAD-CG</p> 
<p>Healing cap for P.A.D. abutments in conventional PEEK, to be used if abutments are not fitted immediately with a temporary prosthesis. Connection screw included (code PAD-VCGP-140), to be tightened with a torque of 8–10 Ncm.</p>	<p>PAD-CGP</p> 
<p>Rotating caps in POM for direct impressions on P.A.D. abutments.</p>	<p>PAD-CAP</p> 
<p>Non-rotating caps in POM for direct impressions on P.A.D. abutments, with hexagon.</p>	<p>PAD-CAP-EX</p> 
<p>Pick-up transfer in Grade 5 titanium for P.A.D. abutments, rotating. Long transfer screw included (code PAD-VTRAL-140), suitable for taking impressions with an individual open tray, and also available as a spare part.</p>	<p>PAD-TRA</p> 
<p>Pick-up transfer in Grade 5 titanium for P.A.D. abutments, with hexagon, non-rotating. Long transfer screw included (code PAD-VTRAL-140), suitable for taking impressions with an individual open tray, and also available as a spare part.</p>	<p>PAD-TRA-EX</p> 
<p>Spare screw for transfer for P.A.D. abutments, long. Supplied with transfers and also available separately as a spare part.</p>	<p>PAD-VTRAL-140</p> 
<p>Transfer screw for P.A.D. abutments, short. Also available separately as a spare part.</p>	<p>PAD-VTRA-140</p> 
<p>Analogue for P.A.D. abutments in Grade 5 titanium.</p>	<p>PAD-ANA</p> 

description	code
Castable sleeves in PMMA for P.A.D. abutments, rotating. Connection screw included Caution: The recommended torque for tightening all over-structures obtained by casting onto abutments is 20–25 Ncm. Care must be taken during laboratory work, before casting, to avoid tightening totally castable sleeves onto models with a torque greater than 8–10 Ncm, because polymers are weaker than metal.	PAD-CC 
Castable sleeves in PMMA for P.A.D. abutments, with hexagon, non-rotating. Connection screw included Caution: The recommended torque for tightening all over-structures obtained by casting onto abutments is 20–25 Ncm. Care must be taken during laboratory work, before casting, to avoid tightening totally castable sleeves onto models with a torque greater than 8–10 Ncm, because polymers are weaker than metal.	PAD-CC-EX 
Sleeves in conventional PEEK for P.A.D. abutments, rotating. These are intended for temporary prostheses or for any necessary relining of a previous prosthesis for use as a temporary one. Connection screw included, to be tightened with a torque of 20–25 Ncm.	PAD-CP 
Sleeves in conventional PEEK for P.A.D. abutments, with hexagon, non-rotating. These are intended for temporary prostheses or for any necessary relining of a previous prosthesis for use as a temporary one. Connection screw included, and also available as a spare part, to be tightened with a torque of 20–25 Ncm.	PAD-CP-EX 
Castable posts in PMMA with a preformed base in gold alloy 1, rotating, not repositionable, for overcasting on P.A.D. abutments. Connection screw included, to be tightened with a torque of 20–25 Ncm. The screw head must never rest directly on the PMMA, but always on the alloy base. The castable sleeve is also available separately as a spare part (code A-CCUCR-330).	PAD-UC 
Castable posts in PMMA with preformed base in cobalt-chrome, rotating, not repositionable, for overcasting on P.A.D. abutments. Connection screw included, to be tightened with a torque of 20–25 Ncm. The screw head must never rest directly on the PMMA, but always on the alloy base. The castable sleeve is also available separately as a spare part (code A-CCUCR-330).	PAD-UCRCO 
Spare screw for prosthetic components for P.A.D. abutments. Supplied together with all components for the over-structure production, and also available as a spare part. Also available in packs of 10 pieces (code PAD-VP-140-10).	PAD-VP-140* 
Sleeves in Grade 5 titanium for P.A.D. abutments, rotating. These are intended for immediate and definitive prostheses or for any necessary relining of a previous prosthesis for use as a temporary one. Connection screw included (code PAD-VP-140), and also available as a spare part, to be tightened with a torque of 20–25 Ncm.	PAD-CT 
Sleeves in Grade 5 titanium for P.A.D. abutments, with hexagon, non-rotating. These are intended for immediate and definitive prostheses or for any necessary relining of a previous prosthesis for use as a temporary one. Connection screw included (code PAD-VP-140), and also available as a spare part, to be tightened with a torque of 25–30 Ncm.	PAD-CT-EX 
Castable cylinders in PMMA for the production of structures to be cemented to titanium sleeves. Effective for prosthetization without residual stresses.	PAD-CCEM 

See respectively pages 85, 86 and 89 for the technical characteristics of Grade 5 titanium, PMMA and gold alloy 1.
 The recommended torque for fixing prosthetic screws is 20–25 Ncm.

*For a longer lifespan of the prosthetic rehabilitation, it is advisable to replace the PAD-VP-140 screws every time the prosthesis needs to be removed and refitted.

All measurements are in mm, unless otherwise indicated.

Insertion of straight P.A.D. abutments

The following pages illustrate the insertion of straight and angled P.A.D. abutments. For purely explanatory purposes, the images show a lower arch with fixtures positioned with the All-on-Four protocol, so as to illustrate the use of both straight and angled abutments. The same insertion procedures are applicable even if rehabilitation envisages the use of a greater number of implants.

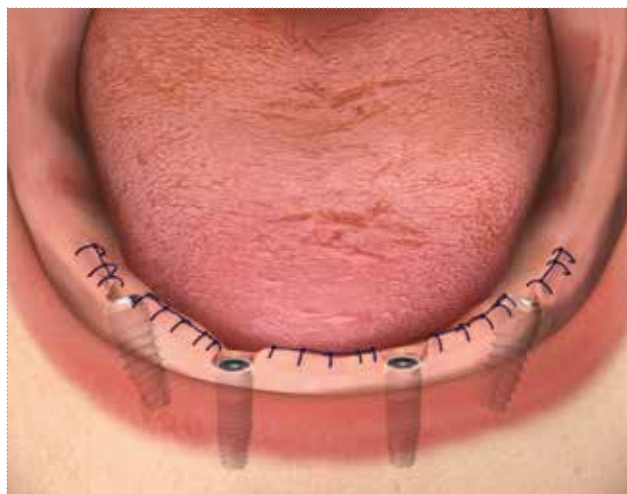

Use the AVV-ABUT-DG abutment carrier supplied in the abutment pack to transport straight P.A.D. abutments into the patient's mouth. The carrier engages the upper hexagon of the P.A.D. abutment, and it is therefore not necessary to fully insert it to obtain the correct retention.

Important warning

Straight P.A.D. abutments are supplied in non-sterile packs. Before being used clinically, titanium abutments only must be sterilized in an autoclave. The AVV-ABUT-DG carrier is made in POM, and can therefore not be sterilized in an autoclave. The carrier must therefore be cold-sterilized before being used to transport an abutment into the patient's mouth.

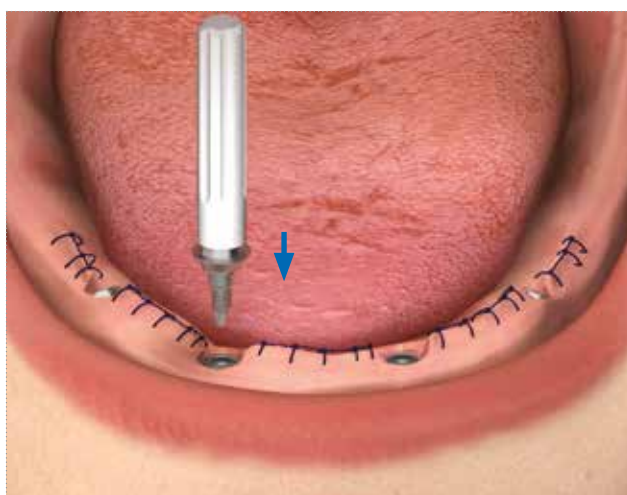

Insert the P.A.D. abutment into the implant connection, identify correct engagement between the abutment thread and the socket thread, and screw in for a few turns. Remove the carrier from the P.A.D. abutment with a slight lever movement,

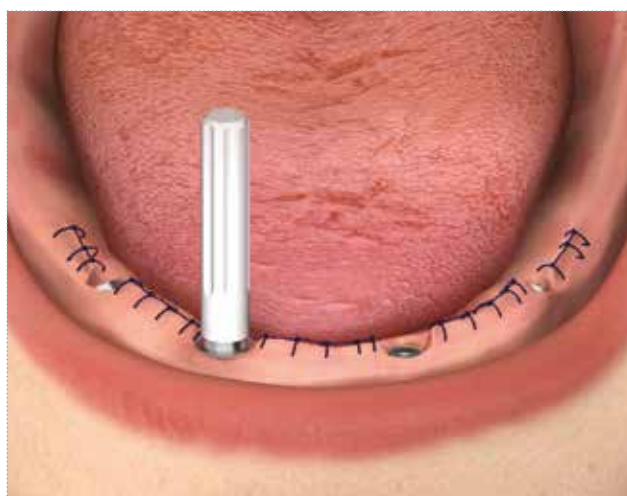

The screwing operation can be completed with the specific hexagonal key (code AVV2-ABUT), which must be purchased separately. This hexagonal key must be connected to the torque-control ratchet (CRI5).



If necessary, an extension (BPM-15), to be fitted between the hexagonal key and the head of the ratchet.

Important warning

To guarantee the correct operation of instruments, periodic checks must be made to ensure that the retention of the rubber O-rings is adequate, replacing any that may be worn.



To stabilize the working axis of the ratchet and the instruments fitted to it, it is advisable to rest the index finger of the free hand on the ratchet wheel on the head of the ratchet.

Important warning

The maximum tightening torque for straight P.A.D. abutments, when directly screwed in, is 25–30 Ncm. The maximum tightening torque for angled P.A.D. abutments, fixed with through screw, is 20–25 Ncm. As it is difficult to control the insertion torque of prosthetic components manually, the procedure must always be completed using the torque-control ratchet.

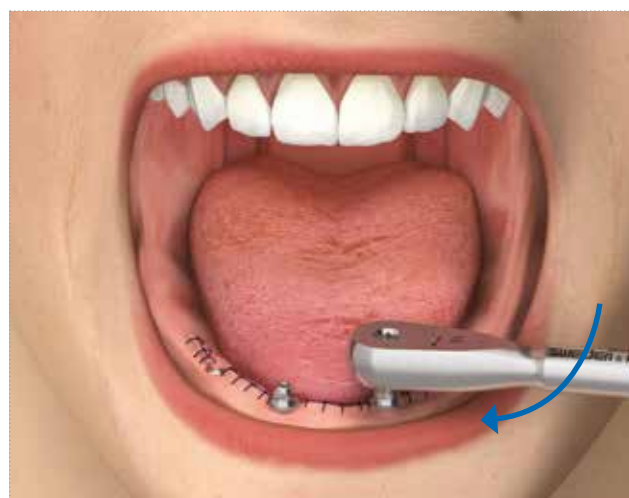

Insertion of angled P.A.D. abutments

Use the HSM-20-DG driver (see pages 19–20) to engage the connection screw (code PAD-VM-180 or PAD-VM-200, depending on the implant connection).

The special design of the instrument makes it possible to exercise a light grip inside the screw head, so that it can be transported and inserted in the hole in the side of the P.A.D. abutment.

Important warning

Angled P.A.D. abutments must be transported into the patient's mouth using the specific PAD-CAR transporter (see page 21) and a transfer screw, also made in titanium, to fix the abutment to the instrument. Before being used clinically, the components must be sterilized in an autoclave.



Position the angled P.A.D. abutment in the lower part of its specific carrier (code PAD-CAR), so that the screw hole of the abutment coincides with one of the two side holes in the carrier, depending on the orientation made necessary by the side of the mouth being operated on. Insert the transfer screw in the upper hole of the carrier (code PAD-VTRA-140 or PAD-VTRAL-140), and tighten it onto the angled P.A.D. abutment.

NB: the transfer screw is not supplied together with the carrier. It can be ordered separately in a single pack. If there is not sufficient vertical spaces, the screw can be used as a carrier, without PAD-CAR, screwing it directly into the prosthetic hole.

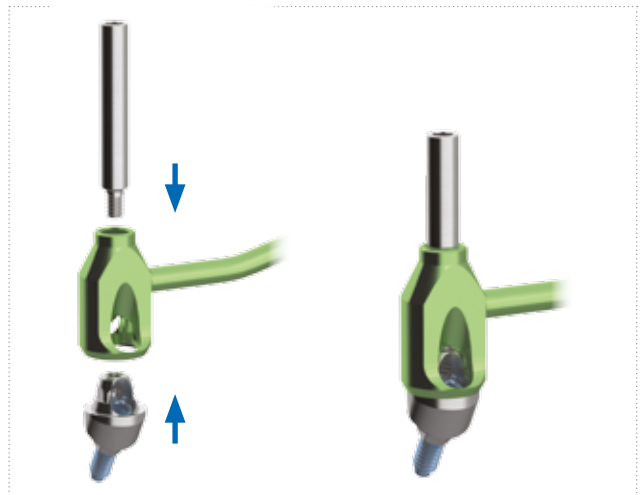

Position the transfer screw/carrier/angled P.A.D. assembly on the implant connection.

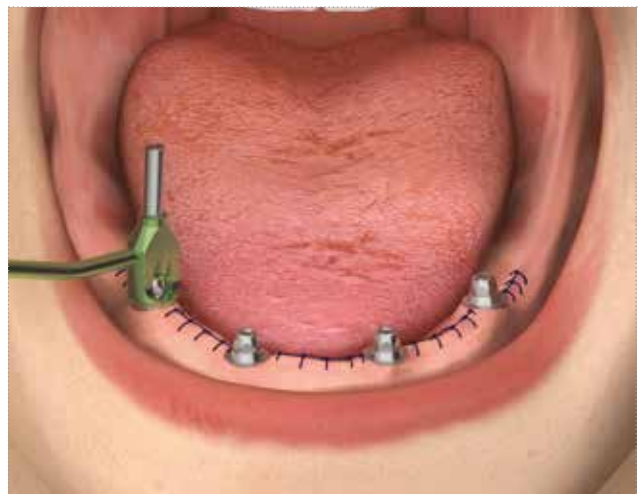

Keeping the abutment in place with the carrier, screw the connection screw fully.

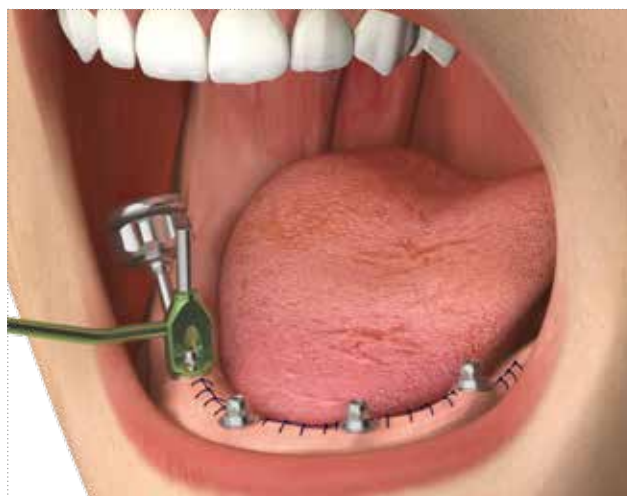

Use the same driver (code HSM-20-DG or HSMXS-20-DG) to unscrew the transfer screw, and then extract the carrier.

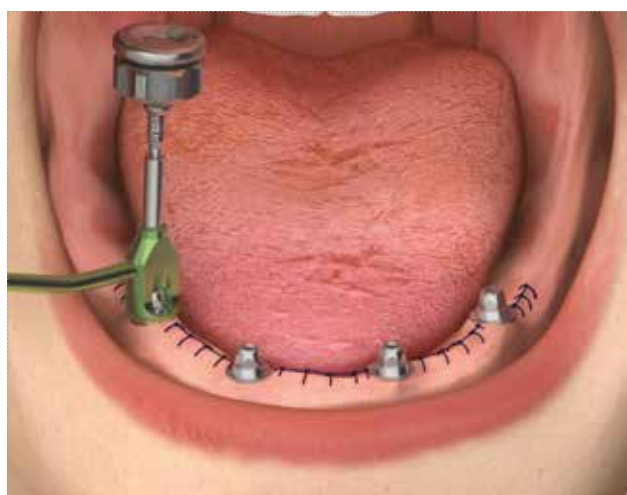

Check for correct manual tightening torque again fitting Allen socket AVV2-ABUT into the CRI5 ratchet.

Important warning

The maximum tightening torque for straight P.A.D. abutments, when directly screwed in, is 25–30 Ncm. The maximum tightening torque for angled P.A.D. abutments, fixed with through screw, is 20–25 Ncm. As it is difficult to control the insertion torque of prosthetic components manually, the procedure should always be completed using the torque-control ratchet. It is advisable to keep the ratchet in a perpendicular position during screwing operations, keeping the index finger of the free hand on the ratchet wheel to prevent swaying movements that could damage instruments and compromise the correct positioning of the abutments.

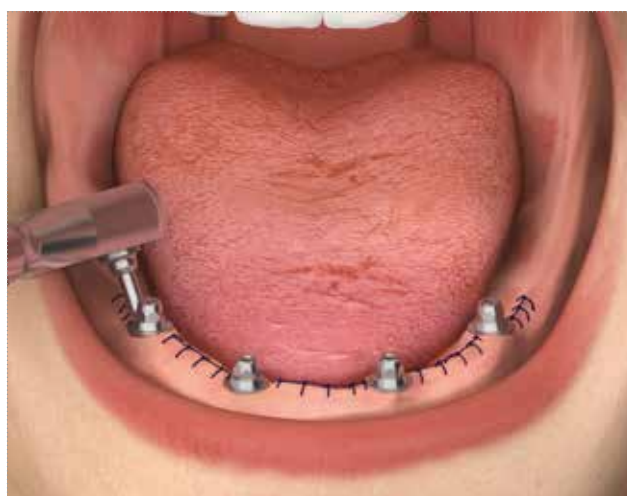

Immediate loading on 4 or 6 implants: cementation technique

Impression on P.A.D. abutments with POM caps

After inserting the P.A.D. abutments in the implant connections, insert with rotating caps PAD-CAP with a slight pressure for the closed-tray technique. No screws are used, because these caps directly grip the taper of the abutment. They are particularly indicated for cases of slight disparallelism of emergence platforms. See page 87 for the technical characteristics of POM. If desired, some light body impression material can be injected around the PAD-CAP.



Position the closed impression tray on the caps, attempting to avoid lateral movements that may cause them to move accidentally. Leave the impression material following the manufacturer's instructions, and lift the tray vertically.

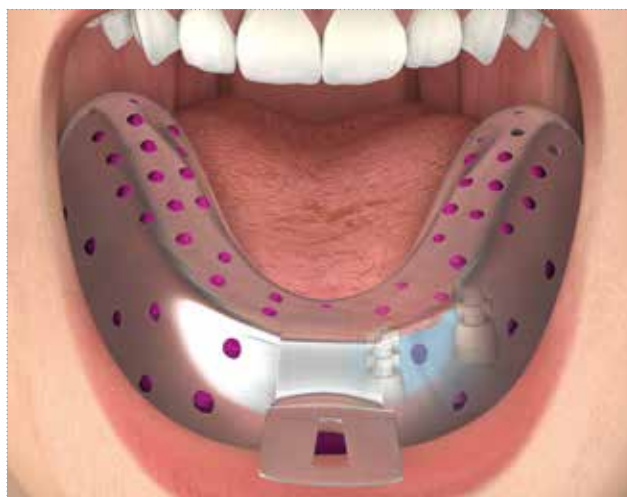

If the abutments are not to be immediately loaded and must be protected while they remain in the oral cavity, they can be covered with the specific PAD-CG titanium protection cap (**Fig. A**), or with the PAD-CGP caps in PEEK (**Fig. B**), which are smaller and can therefore be more easily hidden by a temporary prosthesis. These caps must be fitted onto the abutments using the screws provided. The recommended torque for tightening protection caps screws is 8–10 Ncm.

Important warning

Both types of protection cap are sold in non-sterile packs, and they must therefore be sterilized in an autoclave before clinical use, following the instructions given on page 97.



Position the PAD-ANA analogues in the impression tray, engaging them in the rotating caps.



Develop the model using normal methods.

Important warning

During laboratory work, always use spare screws, available in single packs with codes PAD-VM-180 for abutments with 3.30 and 3.80 mm connections, and PAD-VM-200 for 4.25, 5.00 and 6.00 mm connections. Use new screws for final tightening in the patient's mouth.



Immediate loading on 4 or 6 implants: cementation technique

Impression on P.A.D. abutments with Pick-up transfers

After inserting the P.A.D. abutments into the implant connections, screw on the PAD-TRA rotating Pick-up transfers.

Transfers are sold complete with their respective long transfer screw PAD-VTRAL-140, suitable for taking an impression with an individual open tray. Screws can also be purchased separately as spare parts.

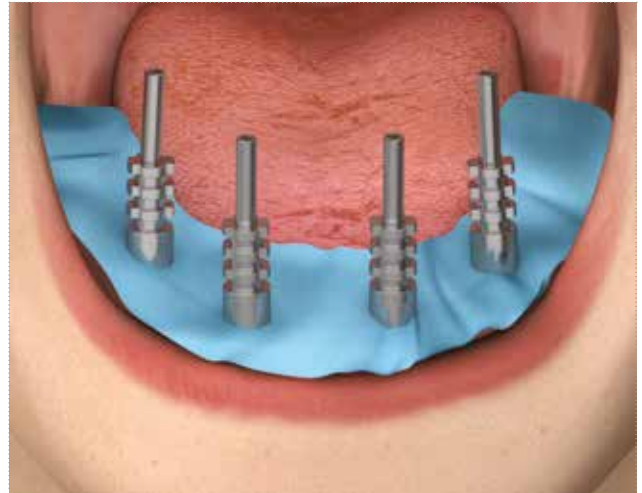

If desired, fix the transfers together with wire and resin, and wait for polymerization to be completed, as indicated by the manufacturer. The connection morphology of rotating P.A.D. prosthesis components facilitates the insertion of structures in case of disparallelisms. If desired, some impression material can be injected around the transfers and the verification jig prior to placing the tray with the material in it.

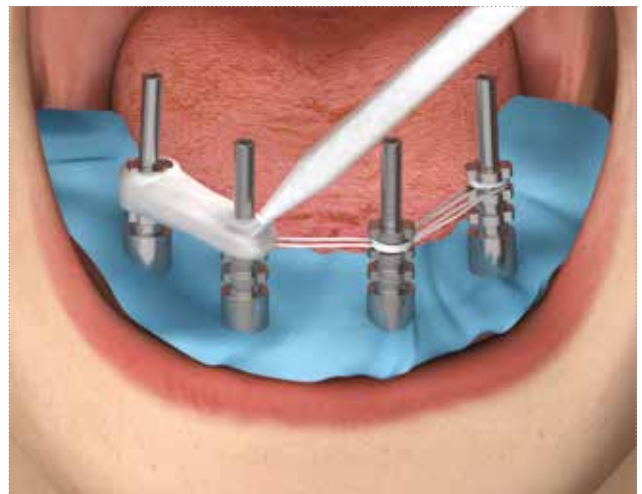

Position the individual open tray on the transfers. The screw will protrude from the holes created specifically in the individual tray. When the impression material has completely hardened, unscrew the transfer screws and remove the impression tray.

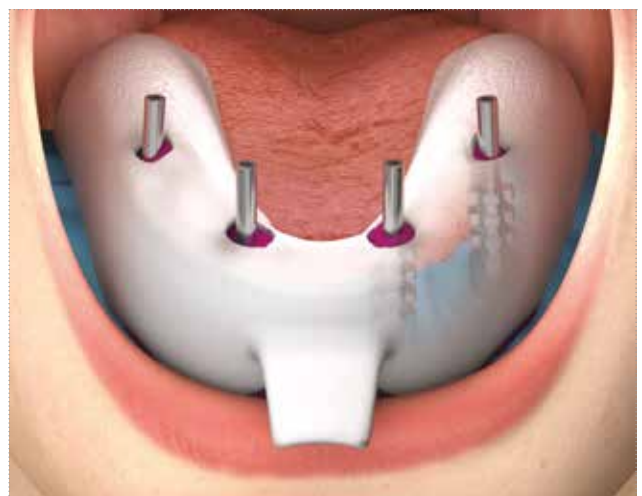

If the abutments are not to be immediately loaded and must be protected while they remain in the oral cavity, they can be covered with the specific PAD-CG titanium protection cap (**Fig. A**), or with the PAD-CGP caps in PEEK (**Fig. B**), which are smaller and can therefore be more easily hidden by a temporary prosthesis. These caps must be fitted onto the abutments using the screws provided. The recommended torque for tightening protection caps screws is 8–10 Ncm.

Important warning

Both types of protection cap are sold in non-sterile packs, and they must therefore be sterilized in an autoclave before clinical use, following the instructions given on page 97.

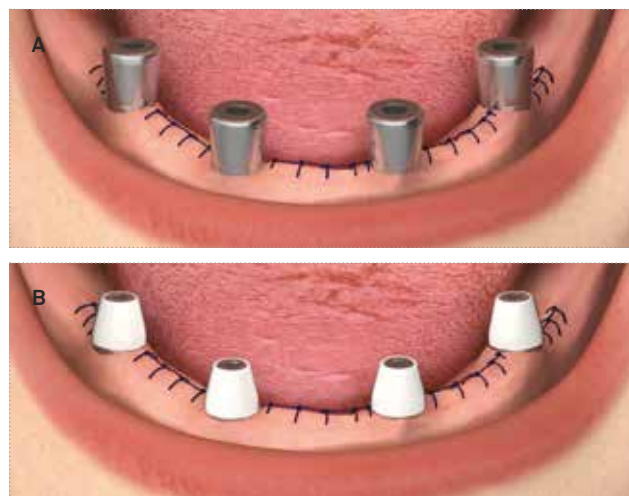

Position the PAD-ANA analogues in the impression tray, engaging them in the transfers, and screw in the screw, repositioning it in the hole by the screw in the impression material.



Develop the model using normal methods.

Important warning

During laboratory work, always use spare screws, available in single packs with codes PAD-VM-180 for abutments with 3.30 and 3.80 mm connections, and PAD-VM-200 for 4.25, 5.00 and 6.00 mm connections. Use new screws for final tightening in the patient's mouth.



Immediate loading on 4 or 6 implants: cementation technique

Production of a prosthesis with a reinforced structure

Using the specific screws supplied (code PAD-VP-140), screw a titanium rotating sleeve (code PAD-CT) onto every P.A.D. analogue.

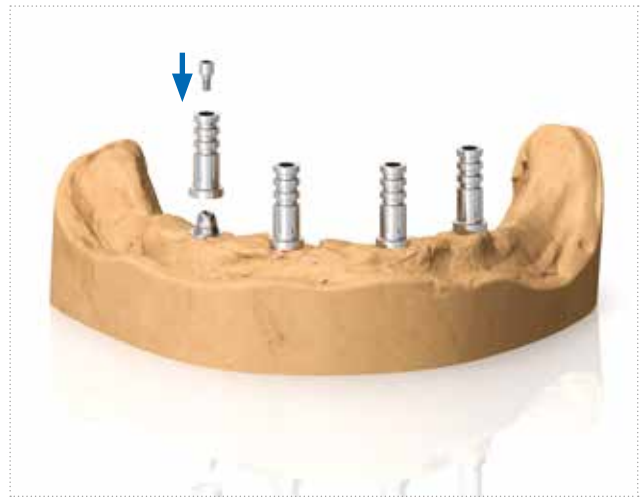

Fit a castable PMMA cylinder (code PAD-CCEM) onto every titanium sleeve.

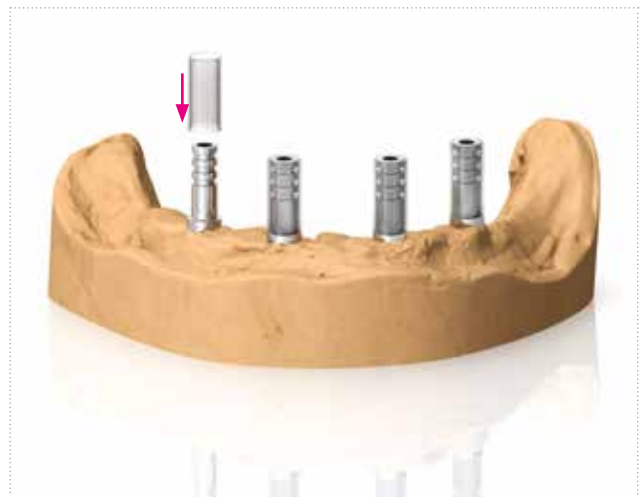

Reduce the titanium sleeves and their respective castable cylinders to a size compatible with the patient's vertical dimension, using the silicone mask obtained from a preassembly or by placing the structure in an articulator in relationship to the space left by the antagonist.



Model a resin truss that incorporates the castable cylinders.



Remove the structure from the model and proceed with casting or a replica using CAD/CAM following normal methods. The titanium sleeves remain screwed onto the P.A.D. abutments.



Proceed with the production of the aesthetic part of the prosthesis, using normal methods. Check the passivity of the structure first on the model and then in the patient's mouth.



continues...

...continued

IN THE SURGERY: Invert the temporary prosthesis and insert resin cement between the cast truss and the titanium sleeves.



Fit the temporary prosthesis onto the titanium sleeves, previously replaced in the patient's mouth, and screwed to the P.A.D. abutments with the respective screws.

NB: take great care to correctly position the titanium sleeves the patient's mouth, following the order of the model, so as to avoid creating discomfort and functional difficulties. Soft tissues can be protected by inserting a suitable shaped rubber dam to prevent sutures from being incorporated in the cement.



Polymerize the cement following the manufacturer's instructions.



Unscrew the temporary prosthesis and trim the base. The titanium sleeves will remain incorporated by the cement inside the prosthesis. The P.A.D. abutments will remain screwed onto the implants. After polishing the base, screw the temporary prosthesis onto the P.A.D. abutments with a torque of 20–25 Ncm. Check for occlusal relationships and for the absence of stresses. Preserve the screw heads and close the screw holes with a removable material, such as a composite or a resin. You should also instruct to turn the prosthesis over and fill in any gaps that the cement might have missed on the bottom side of the prosthesis

Important warning

New screws must be used for definitive fixing of the structure in the patient's mouth.

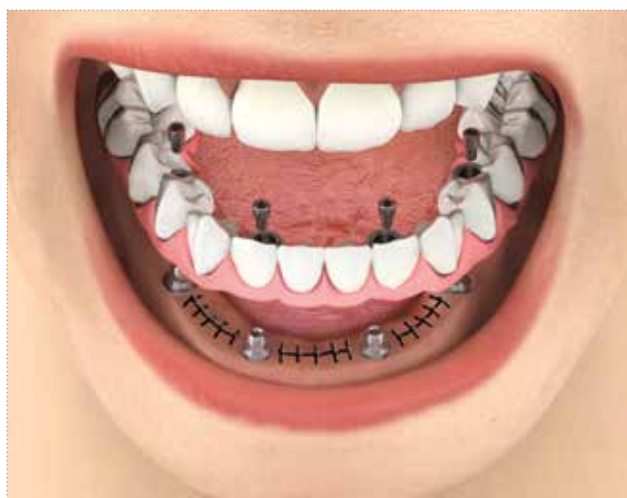
**Important warning**

For patients already fitted with an overdenture, a temporary prosthesis anchored on implants can be created, using the same PAD-CT titanium sleeves or the version in PEEK (code PAD-CP). In this case, the existing prosthesis must be perforated at the positions of the implants, and then glued/cemented onto these sleeves, relining directly in the patient's mouth. The excess parts of sleeves must then be cut away, to avoid discomfort and functional problems.

Immediate loading on 4 or 6 implants: Direct Prosthetic Framework (D.P.F.) technique

D.P.F. components were specifically developed to facilitate impression protocols and the transfer to a laboratory of multiple rehabilitations with P.A.D. abutments, regardless of their number. The intraoral cementation of the metal truss obtained subsequently by casting makes it possible to reduce insertion times for a reinforced temporary prosthesis to 8 hours after the completion of surgery, at the same time conserving all the important requirements of resistance and passivity during the initial phase of implant loading.

STEP 1

The castable bar is fixed to the caps with a photopolymerizing resin.









STEP 3

The structure is cast in the laboratory, and a metal structure for the production of the finished truss is obtained.

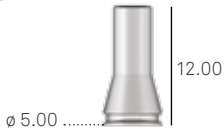

STEP 2

After photopolymerization of the truss, the structure is removed from the oral cavity.

description	code
<p>Pack complete with all prosthetic components for the D.P.F. technique on single P.A.D. abutments.</p> <p>The pack includes a sleeve in Grade 5 titanium (PAD-CT-LV), a castable centring device (PAD-CC-LV), an anti-escape plug (PAD-TR-LV), a protection O-ring (PAD-ORING-LV) and a fixing screw (PAD-VP-140) to be tightened with a torque of 20–25 Ncm, and also available as a spare part.</p>	<p>PAD-LV</p> 
<p>Spare sleeve in Grade 5 titanium for the D.P.F. technique.</p> <p>The pack does not include the connection screw.</p>	<p>PAD-CT-LV</p> 
<p>Spare castable centring device for the D.P.F. technique.</p>	<p>PAD-CC-LV</p> 
<p>Spare anti-escape plug for the D.P.F. technique.</p>	<p>PAD-TR-LV</p> 
<p>Spare O-ring for the D.P.F. technique.</p>	<p>PAD-ORING-LV</p> 
<p>Spare screw for prosthetic components for P.A.D. abutments.</p> <p>Supplied together with all components for over-structure production, and also available as a spare part.</p> <p>Also available in packs of 10 pieces (code PAD-VP-140-10).</p>	<p>PAD-VP-140</p> 
<p>Castable bar, length 5 cm, Ø 2.2 mm</p>	<p>BARC</p> 

See page 85 for the technical characteristics of Grade 5 titanium.

All measurements are in mm, unless otherwise indicated.

Immediate loading on 4 or 6 implants: Direct Prosthetic Framework (D.P.F.) technique

Production of a prosthesis with a reinforced structure

Before suturing the surgical wound, screw a P.A.D. abutment onto every implant, with a suitable transgingival height for the thickness of the patient's soft tissues. Then apply sutures as required by clinical indications.

Important warning

Straight P.A.D. abutments are supplied in non-sterile packs. Before being used clinically, they must be sterilized. Abutments are made in titanium, and can therefore be sterilized in an autoclave. The AVV-ABUT-DG carrier is made in POM, and can therefore not be sterilized in an autoclave, but must instead be cold-sterilized before being used to transport an abutment into the patient's mouth.



Push the black O-ring down to the base of the sleeve, until it rests in the groove provided. A probe can be used to facilitate this operation.



Using the specific screw provided, screw a titanium sleeve for the D.P.F. technique (code PAD-CT-LV) fitted with its black O-ring (code PAD-ORING-LV) onto every P.A.D. abutment. Then fit a castable centring device (code PAD-CC-LV) onto every sleeve.

Important warning

Components for the D.P.F. technique are sold in non-sterile packs, with a kit for every single P.A.D. abutment. Every kit contains all necessary components, as indicated on page 75. Before being used clinically, components must be sterilized in an autoclave. It is advisable to also cold-sterilize the silicone O-ring and the castable centring device before inserting them in the patient's mouth.



Create a castable resin structure on the PAD-CC-LV elements using preformed segments (code BARC) and a liquid photopolymerizing resin **(A)**. Finally thicken the truss with another layer of resin **(B)**.



When polymerization is complete, unscrew the PAD-VP-140 screws and remove the entire resin structure with the PAD-CT-LV sleeves still inserted.

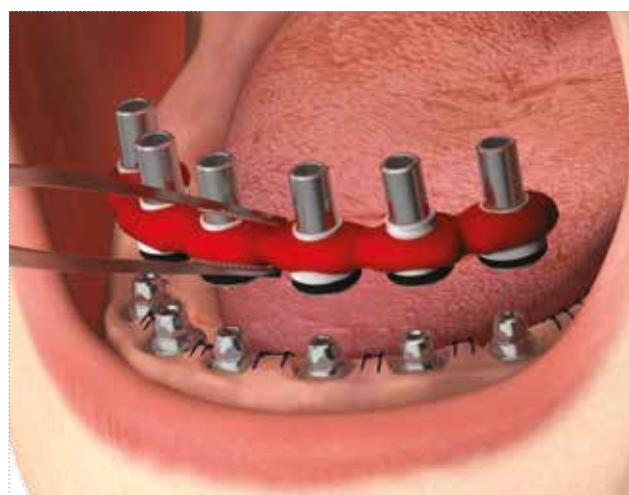

IN THE LABORATORY: If necessary thicken the structure even further. Remove the titanium sleeves and their respective screws before casting the truss.



continues...

...continued

Cast the structure using the standard protocol. Test the structure in the patient's mouth, checking for its complete passivity.

The recommended torque for tightening all over-structures obtained by casting onto P.A.D. abutments is 20–25 Ncm. Replace the titanium sleeves in the truss, which is kept in the correct position by the specific anti-escape plugs. Insert the PAD-VP-130 screws again from the top of the sleeves, and inject a small quantity of petroleum jelly into the sleeves, to prevent the screws from escaping during transport to the surgery.



IN THE SURGERY: Invert the structure received from the laboratory and insert resin cement between the cast truss and the titanium sleeves.



Screw the structure onto the P.A.D. abutments with a torque of 20–25 Ncm, and polymerize the cement following the manufacturer's instructions.



If necessary, the technician can shorten the sleeves to conform to the patient's vertical dimension.

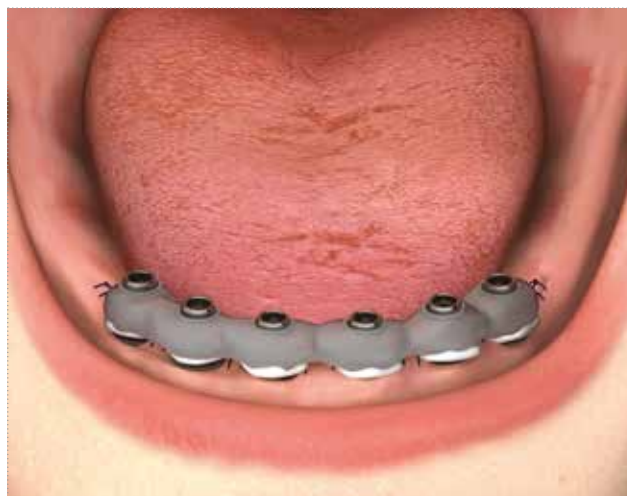

Remove all the PAD-VP-140 screws, except for one in a mesial position.



Using an individual tray, perforated at the position of the screw left in place, take an impression that incorporates the cast truss, fixed previously to the titanium sleeves. Then excavate the impression at the position of the screw.

NB: the PAD-VP-140 screw can be substituted with a PAD-VTRAL-140 transfer screw. In this way, it will no longer be necessary to excavate the impression, but it will be sufficient to unscrew the screw by turning it from the end projecting from the tray.

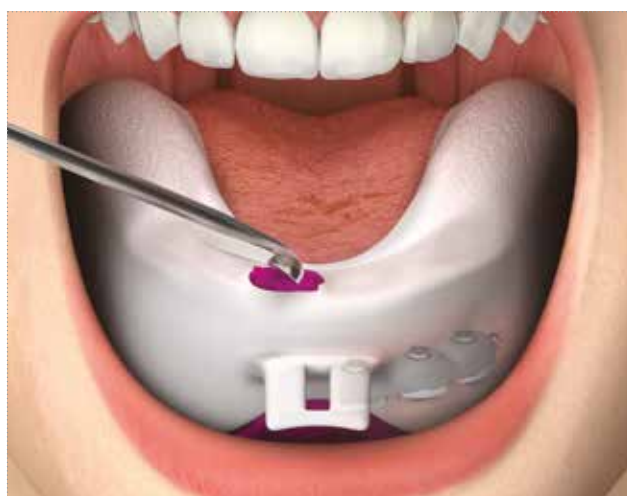

continues...

...continued

Unscrew the PAD-VP-140 screw or the transfer screw.



Lift the impression tray, inside which the truss will be incorporated.



Position the PAD-ANA analogues in the impression tray, engaging them at the base of the cast structure.



Cast the model and free the truss from the impression, then screwing it back onto the analogues of the P.A.D. abutments.

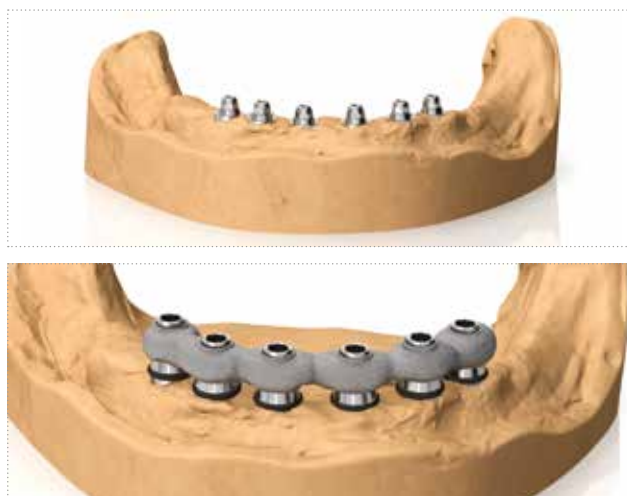

Produce temporary resin prosthesis using normal methods, and trim the base to ensure greater comfort for the patient.



Screw the temporary prosthesis into the patient's mouth and close the holes with temporary cement.

NB: the PAD-VP-140 screw can be substituted with a PAD-VTRAL-140 transfer screw. In this way, it will no longer be necessary to free the impression, but will be sufficient to unscrew the screw by turning it from the end projecting from the tray.



Deferred loading on 4 or 6 implants

Production of a definitive prosthesis by casting or with CAD/CAM methods

Remove the temporary prosthesis and take a definitive impression on the P.A.D. abutments with Pick-up transfers and an individual tray, following the same procedures indicated on page 68, and then casting the model using normal methods. Reposition the temporary prosthesis in the patient's mouth.



Screw the PAD-CC castable sleeves onto the abutments. Care must be taken during laboratory work, before casting, to avoid tightening totally castable sleeves onto models with a torque greater than 8–10 Ncm, because polymers are weaker than metal. See page 86 for the technical characteristics of PMMA.

Important warning

During laboratory work, always use spare screws, available in single packs with codes PAD-VM-180 for abutments with 3.30 and 3.80 mm connections, and PAD-VM-200 for 4.25, 5.00 and 6.00 mm connections. Use the definitive screws only for final tightening in the patient's mouth.



Reduce the castable sleeves to a size compatible with the patient's vertical dimension, using the silicone mask obtained from a preassembly or by placing the structure in an articulator in relationship to the space left by the antagonist.

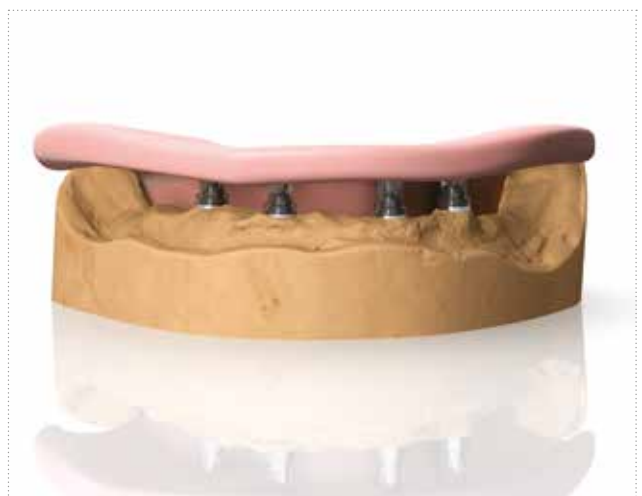

Make a castable structure, which will allow the metal framework of the final prosthesis to be obtained.

Alternative option

Starting from the same wax-up, the structure can also be produced by duplication using CAD/CAM technology.



Cast the structure using the standard protocol. Test the structure first on the model and then in the patient's mouth, checking for its complete passivity.

Important warning

If the structure is not completely passive, even though the normal checking protocol has been followed before casting, any stresses detected can be corrected if necessary by cutting the structure at one or more points, and rewelding it in the correct position.

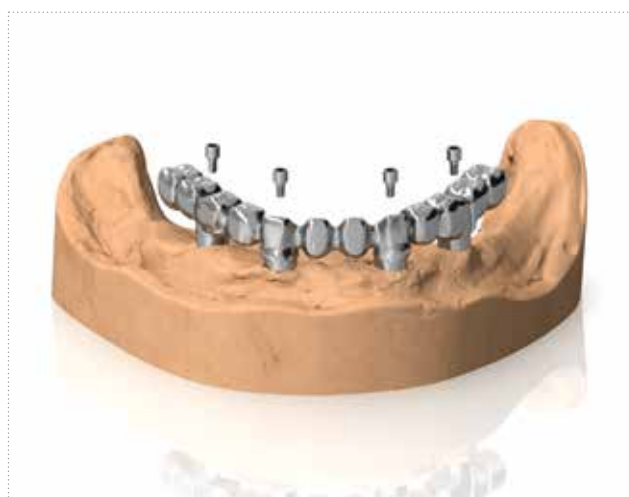

Apply the ceramic finish to the definitive prosthesis using normal methods, and screw it onto the P.A.D. abutments in the patient's mouth. Preserve the screw heads and close the screw holes with a removable material, such as a composite or a resin.

The recommended torque for tightening all over-structures obtained by casting onto abutments is 20–25 Ncm.



Composition of materials

Grade 4 titanium (cold-worked)*

chemical composition	maximum allowed values (%)	tolerance
nitrogen	0.05	+/- 0.02
carbon	0.08	+/- 0.02
hydrogen	0.015	+/- 0.002
iron	0.50	+/- 0.10 (%<0.25) +/- 0.15 (%>0.25)
oxygen	0.40	+/- 0.02 (%<0.20) +/- 0.03 (%>0.20)
titanium	remainder	-

mechanical properties	minimum allowed values (%)
tensile stress	680 MPa (N/mm ²)
yield strength (0.2%)	520 MPa (N/mm ²)
elongation at yield	15 %
necking	25 %

* This technical information complies with the express requirements of applicable standards for the use of Grade 4 titanium in implantology.

NB: the use of cold-worked bars for the production of Sweden & Martina SpA implants gives them mechanical characteristics of tensile stress and yield strength around 15% higher than those obtainable with hot-worked bars (respectively 550 MPa and 483 MPa).

Grade 5 titanium**

chemical composition:	maximum allowed values (%)	tolerance
nitrogen	0.05	+/- 0.02
carbon	0.08	+/- 0.02
hydrogen	0.012	+/- 0.002
iron	0.25	+/- 0.10
oxygen	0.13	+/- 0.02
aluminium	5.50÷6.50	+/- 0.40
vanadium	3.50÷4.50	+/- 0.15
titanium	remainder	-

mechanical properties	minimum allowed values (%)
tensile strength (for bar diameters up to 44.45 mm)	860 MPa (N/mm ²)
yield strength (0.2%)	795 MPa (N/mm ²)
elongation at yield	10 %
necking	25 %

* This technical information complies with the express requirements of applicable standards for the use of Grade 5 titanium in implantology.

PMMA

PMMA	
chemical designation	polymethylmethacrylate
colour	transparent

physical and mechanical properties	
density (DIN 53479):	1.18 g/cm ³
compressive yield strength (ISO 527, DIN 53454)	110 N/mm ²
elongation at breaking point (DIN 53455, ISO 527)	5.5 %
flexural strength	115 N/mm ²
modulus of elasticity (ISO 527, DIN 53457)	3300 N/mm ²
modulus of rigidity at ca. Hz (DIN 53445)	1700 N/mm ²
Brinell ball hardness (DIN 53456)	200 N/mm ²

thermal properties	
linear expansion coefficient for 0...50° (DIN VDE 0304/01):	70-10 · 1/°C
thermal conductivity (DIN 52612)	0.19 W/m °C
oven temperature	≈ 160 °C
tempering temperature	>80 °C
maximum constant operating temperature	78 °C
Vicat softening temperature procedure B (DIN 3460)	115 °C
thermal indeformability ISO 75 bending stress 1.80 N/mm ² (DIN 53461)	105 °C
Martens thermal indeformability (DIN 53458)	95 °C

miscellaneous data	
water absorption by weight increase after 1 day of immersion (DIN 53495):	0.3 %

POM

POM	
chemical designation	polyoxymethylene (copolymer)
colour	opaque white

physical and mechanical properties	
density (DIN 53479):	1.41 g/cm ³
yield strength (DIN 53455):	65 MPa
elongation at breaking point (ISO 527, DIN 53455):	40 %
modulus of elasticity in tension (ISO 527, DIN 53455):	3100 MPa
ball impression hardness (30s) DIN 53456:	155 MPa
impact strength (Charpy, DIN 53453):	Non rotto
creep rupture strength (after 1000 hours with static load):	40 MPa

thermal properties	
melting point (DIN 53736):	165 °C
glass transition temperature (DIN 53736):	-60 °C
dimensional stability temperature (method A, ISO 75):	110 °C
dimensional stability temperature (method B, ISO 75):	160 °C
maximum temperature for short-term use:	140 °C
maximum temperature for continuous use:	100 °C
specific thermal capacity:	1.5 J/(gK)
thermal conductivity:	0.31 W/ (mK)
coefficient of linear thermal expansion:	10·10 ⁻⁵ /K

miscellaneous data	
humidity absorption: equilibrium in standard atmosphere (23°C / 50% RH, ISO 62, DIN 53714):	0.3 %
water absorption to saturation at 23°C (ISO 62, DIN 53495):	0.5 %

PEEK

PEEK	radiopaque	classic
chemical designation	polyether ether ketone	polyether ether ketone
colour	opaque cream white	opaque cream white

physical and mechanical properties	radiopaque	classic
density	1.65 g/cm ³	1,4 g/cm ³
modulus of elasticity in tension (DIN EN ISO 527-2)	5200 MPa	4100 MPa
yield strength (DIN EN ISO 527-2)	77 MPa	97 MPa
yield strength at 0.2% (DIN EN ISO 527-2)	77 MPa	97 MPa
elongation at 0.2% (DIN EN ISO 527-2)	2 %	5 %
elongation at breakage (DIN EN ISO 527-2)	2 %	13 %
flexural strength (DIN EN ISO 178)	178 MPa	174 MPa
modulus of flexural elasticity (DIN EN ISO 178)	5000 MPa	4000 MPa
modulus of compressibility (EN ISO 604)	4000 MPa	3500 MPa

thermal properties	radiopaque	classic
glass transition temperature	-	150 °C
maximum temperature for short-term use:	300 °C	300 °C
maximum temperature for continuous use:	260 °C	260 °C

chemical properties	radiopaque	classic
absorption at 23°C in 24/96 hours (DIN EN ISO 62)	-	0.02/0.03 %

Gold alloy

Gold alloy 1	
chemical designation	gold alloy 1
colour	white

composition	gold alloy 1
Au	60%
Pt	24%
Pd	15%
Ir	1%
Ag	-
Cu	-
Zn	-
Au+Pt-group metals	-
Ru	-

physical and mechanical properties	gold alloy 1
density	18.1 g/cm ³
melting range	1400 ÷ 1460 °C
modulus of elasticity in tension	115 GPa
Vickers hardness HV1 (gold alloy 1) HV5 (gold alloy 2, gold alloy 3)	160 (annealed) 250 (tempered) 220 (after deformation) 240 (after casting)
limit of elasticity	400 MPa (annealed) 700 (after deformation) 800 (after casting)
elongation	20% (annealed) 15% (after deformation) 1% (after firing)

Cobalt-chrome alloy

chemical composition	maximum allowed values (%)
C	0.10
Mn	1.00
Cr	26.00 ÷ 30.00
Ni	1.00
Mo	5.00 ÷ 7.00
N	0.25
Fe	0.75
Co	remainder

physical and mechanical properties	maximum allowed values (%)
density	8.27 g/cm ³
modulus of elasticity in tension	241 GPa
yield strength (0.2%)	585 MPa
tensile stress	1035 MPa
elongation at yield	25 %
necking	23 %
hardness	30 HRc

thermal properties	maximum allowed values (%)
melting range	1400 ÷ 1450 °C
coefficient of thermal expansion at 500°C	14.15
coefficient of thermal expansion at 600°C	14.47
thermal conductivity at 600°C	25.76 W/mK

Advice for overcasting with base alloys

By **Loris Zamuner, dental technician**

Casting with base alloys, which is less predictable than casting with precious alloys, increases the difficulty of maintaining precision at the level of the prosthetic connection, because apart from the factors involving intimate contact between the alloys and mechanical resistance, problems of corrosion may also emerge, as dental technicians are well aware.

As these alloys are oxidized when heated, additional precautions must be adopted when preparing models and during coating and casting procedures, to avoid not only mechanical but also biological complications (e.g. gingival tattoos, namely the blackish marks caused by the redox reaction of prosthesis metals, which are extremely difficult to treat and remove).

With regard to this we would like to offer some advice, which although it may not completely eliminate these problems, may be useful in the laboratory for the correct use of castable posts with a cobalt-chrome base:

- Remove the castable sleeve from the base and seal the interstitial space with wax or castable resin, to prevent the possible formation of cracks.
- Apply a layer of deoxidizing solution (e.g. flux) to the metal surface before repositioning and fixing the castable sleeve. This may reduce the quantity of oxides produced during heating of the alloy.
- Modelling must very clearly delimit the area of the junction between the castable sleeve and the prefabricated base with a well-defined closure edge, so as to prevent the overcast alloy from penetrating the base of the post.
- The formation of pins for the creation of cylinders must be carried out in an area with an adequate surrounding volume, to prevent the injected alloy from cooling before it has completely filled the final form. Do not position casting pins in thin areas, to avoid deformations caused by the heat of the molten alloy.
- The expansion of the refractory casting coating must be limited to a minimum, to prevent the formation of spaces between the metal base and the coating caused by the different expansion of the two layers. If the coating and the metal base are not in intimate contact, a thin film of metal could form on the prefabricated base, which if it reaches the connection platform between the implant and the prosthesis could affect precision, giving rise to evident biomechanical and biological problems.
- All parts of the cylinder must be heated uniformly. Since internally it incorporates the prefabricated metal components, which by their very nature absorb heat, it is advisable to maintain the final heating temperature for an extended time, then raising it by about 20–30°C higher than the temperature recommended by the manufacturer of the alloy.
- When choosing the alloy for overcasting, its fusion temperature must be attentively considered with respect to the fusion temperature of the component to be overcast, which must be around 80–100°C higher, to avoid deformations but at the same time to ensure correct bonding between the two alloys.
- After casting, leave the cylinder to cool slowly, to prevent the formation of stresses between the two alloys.
- Avoid contact between the ceramic and the base alloy while firing the ceramic, because the different thermal expansion coefficients may cause cracking in the coating layer.
- Where possible (in non-aesthetic areas) keep the area of interface between the prefabricated base and the overcast structure out of the gingival sulcus.
- With composite screw-retained prostheses, incorporate the interface line between the prefabricated base and the overcast structure inside the aesthetic coating.
- Use the same type of alloy for the entire prosthetic reconstruction, to avoid partial weakening, breakages and the incorrect distribution of forces on the implants.

Remember that this technique may be subject to the problems of mechanical resistance, corrosion and galvanic reactions typical of precious alloys, which are therefore present to a greater extent in base alloys.

General clinical indications

Modern implant prosthetics, for both immediate or deferred loading, is a widely experimented and reliable discipline that is able to resolve virtually all problems of functional or aesthetic edentulism. An implant prosthesis may replace a single tooth (implant-supported crown), a group of adjacent teeth (implant-supported bridge), or an entire dental arch.

This manual addresses the production screw-retained prostheses for the rehabilitation of cases of total edentulism.

Implant-prosthetic rehabilitation must respect several fundamental criteria:

- the presence of a certain quantity of bone;
 - the primary stability of the inserted implants;
 - good periodontal (gingival) support;
 - the absence of bruxism (tooth grinding) and serious malocclusions;
- the presence of good occlusal balance (correct masticatory occlusal plane).

Warnings and contraindications

When assessing patients, in addition to considering their suitability for implant-prosthetic rehabilitation, it is usually necessary to take into account the contraindications applicable to all operations of dental surgery.

These may include:

- clotting disorders, anticoagulant therapies in progress;
- healing or bone regeneration disorders;
- decompensated diabetes mellitus;
- metabolic or systemic diseases that compromise tissue regeneration, and with effects in particular on tissue healing and bone regeneration;
- alcohol abuse, smoking and use of drugs;
- immunosuppressive therapy, such as chemotherapy and radiotherapy;
- infections and inflammations, such as periodontitis and gingivitis;
- poor oral hygiene;
- insufficient motivation;
- occlusion and/or articulation disorders, and also inadequate interocclusal space;
- inadequate alveolar process.

It is contraindicated to fit implants and implant restorations in patients with poor general or oral health, those who are unable to monitor their general conditions properly or those who have had organ transplants. Psychologically unstable patients, alcohol or drug abusers and poorly motivated or uncooperative patients should also be considered unsuitable for this kind of treatment. Patients with poor periodontal health should first be treated and allowed to recover. In the presence of a lack of bone substance or poor quality of the receiving bone, such as to compromise the stability of the implant, suitable guided tissue regeneration must be performed prior to implant treatment and bone grafting procedures. Contraindications can also include: allergies to titanium, acute or chronic infectious diseases, sub-acute chronic maxillary osteitis, systemic diseases, endocrine disorders, diseases resulting in microvascular disorders, pregnancy, breastfeeding, previous exposure to radiation, haemophilia, granulocytopenia, use of steroids, diabetes mellitus, kidney failure and fibrous dysplasia. The normal contraindications common to all oral surgery must also be observed. Patients following anti-coagulant, anticonvulsant and immunosuppressant therapies, with active inflammatory-infective processes of the oral cavity, and patients with BUN and creatinine values outside the norm, must not be subjected to surgery. Patients with cardiovascular disease, hypertension, thyroid or parathyroid diseases, malignant tumours found in the five years preceding the operation or nodular swellings must also be assessed with particular attention. Chemotherapies reduce or eliminate the ability of osseointegration, and patients undergoing these treatments must therefore be carefully screened before being rehabilitated with oral implant prostheses. Numerous cases of bisphosphonate-associated peri-implant osteonecrosis of the mandible have been reported in literature. This problem applies in particular to patients receiving intravenous treatments.

Prostheses must always be programmed in advance. Prosthetic planning must be carried out in collaboration with the dental technician. Guided prosthetic insertion of implants facilitates the work of the practitioner, and offers greater guarantees of longer prosthesis lifespan. Complete clinical, radiological and radiographic documentation should be collected and stored on file. Every product pack shows the product code, a description of contents and the batch number. These details are also indicated on the labels to be attached to the patient's records, and must always be cited by the practitioner in any correspondence regarding the products. When handling these medical devices, both during actual use and during cleaning and sterilization procedures, surgical gloves must always be worn for individual protection against bacterial contamination. Failure to follow this precaution may expose the patient to infection. Packaging conforms to European standards.

Information on applicable standards

The medical devices addressed by this instruction manual have been designed and manufactured in accordance with the most recent directives and harmonized standards applicable to the materials used, production processes, the information supplied and packaging.

Every product pack shows the product code, a description of contents and the batch number. These details, which are also indicated on labels included in packs, must always be cited by the practitioner in any correspondence regarding the products.

The prosthetic components and instruments manufactured by Sweden & Martina contains no materials of human or animal origin, and are free from phthalates. Patients must be asked if they are allergic to any of the materials used.

Although titanium allergies are possible, these are very rare. Patients should therefore always be asked if they have allergies of this type.

Refer to pages 84–90 for technical details on all materials used, for checks on the respective chemical compositions, and for physical and mechanical characteristics.

Identification of the manufacturer

Manufacturer of the prosthetic components and instruments described in this manual:

Sweden & Martina

Via Veneto 10

35020 Due Carrare (Padova) – Italia

Tel. +39 049.9124300 - Fax + 39 049.9124290

e-mail: info@sweden-martina.com

www.sweden-martina.com

Intended use and risk classes

In accordance with Directive 93/42/EEC adopted in Italy with Law Decree 46/97 dated 26 March 1997, Annex IX, Sweden & Martina identifies the prosthetic components and instruments described in this manual as medical devices, and identifies their risk class as indicated in the following chart.

In particular, the prosthetic components described are medical devices intended for use in the oral cavity. The prosthetic components have the following functions:

- reconditioning of the gingiva (transgingival healing abutments, long-term devices);
- taking of impressions (transfers and respective fixing screws, temporary devices, with a certified duration of no more than 60 consecutive minutes);
- anchorage to dental implants for the support of dental prostheses (temporary and definitive posts, their respective fixing screws, long-term devices).

The prosthetic components are disposable. "Disposable" is taken to mean that every single device must be used only for a single patient.

It is routine practice for a prosthetic component to be tested several times in the patient's mouth and then sent to the dental technician for completion of the prosthesis. This is acceptable practice, and does not compromise the concept of "disposable", on condition that the same prosthetic component is used always and only for the same patient. In the case of multiple prostheses, it is essential for the same component to be used always and only in the same position and in association with the same implant, meaning that components must not be interchanged during the same rehabilitation procedure.

Failure to respect these instructions may compromise the precision of the components. Any reuse for different patients must be considered to be an "off-label" use, and in these cases, Sweden & Martina SpA declines all liability.

The instruments are reusable medical devices intended for temporary use in the oral cavity (no more than 60 consecutive minutes). The function of the instruments is to tighten and unscrew all connection screws (surgical cover screws, transgingival healing abutments, screws for posts and abutments, prosthetic screws, transfer screws, etc).

device	classification	pack	annex IX rule	risk class
Transgingival healing abutments	Invasive long-term surgical devices	Disposable, non-sterile	8	2B
Transfers	Invasive short-term surgical devices	Disposable, non-sterile, complete with respective fixing screws	7	2A
Caps for taking impressions on P.A.D. abutments	Invasive short-term surgical devices	Disposable, non-sterile	7	2A
Transfer screws	Short-term accessories for invasive surgical medical devices	Disposable, non-sterile	5	2A
Abutments and components for screw-retained prostheses, conventional type or for the P.A.D. technique	Invasive long-term surgical devices	Disposable, non-sterile, complete with fixing screws	8	2B
Customizable posts, totally castable or castable with a metal base	Long-term non-surgical invasive devices intended for the oral cavity	Disposable, non-sterile. Supplied together with the respective posts or individually, in single or multiple packs	5	2A
Tightening screws for posts, abutments and over-structures (post and prosthesis screws)	Long-term accessories for invasive surgical medical devices intended for the oral cavity	Disposable, non-sterile. Supplied together with the respective posts or individually, in single or multiple packs	5	2A
Analogues	Medical device, non-invasive	Disposable, non-sterile	1	1
Spare castable sleeves	Medical device, non-invasive	Disposable, non-sterile without fixing screws	5	1
Drivers, drivers/screwdrivers and extension with shank for contra-angle handpiece	Invasive surgical instruments for temporary use (for less than 60 consecutive minutes) intended for fitting to an active medical device	Reusable, non-sterile	6	2A
Drivers/screwdrivers, drivers, hexagonal keys, manual drivers, parallelism pins for manual use	Invasive surgical instruments for temporary use (for less than 60 consecutive minutes) intended for fitting to an active medical device	Reusable, non-sterile	6	1

All the devices listed, even though they are intended for use in all patients with suitable therapeutic indications, must be used only by professional medical personnel with the necessary qualifications and training, and by dental technicians in the context of the preparation of prostheses.

Special warnings

When tightening transgingival abutments and definitively tightening screws for posts or prostheses, the following tightening torques must be respected:

description	recommended torque
Transgingival healing abutments	8-10 Ncm
Transfer screws	8-10 Ncm
Through screws for tightening posts and abutments onto implants	20-25 Ncm
Through screws for tightening prosthetic over-structures onto abutments	20-25 Ncm
Components screwed directly onto implants (e.g. straight P.A.D. and PLAIN abutments without a through screw form a solid body with the screw)	25-30 Ncm
Through screws for tightening over-structures screwed directly onto implants (without using intermediate abutments)	25-30 Ncm

Excessive tightening torques may weaken the mechanical structure of screws and compromise prosthetic stability, with possible damage to the implant connection. Totally castable posts must be screwed onto models manually and/or with a torque not exceeding 8–10 Ncm.

Maintenance

Complications associated with implant prostheses have been reported in literature. These complications may lead to a loss of osseointegration and to implant failure. Correct maintenance by the patient, satisfactory home dental hygiene and regular check-ups during professional hygiene sessions increase the lifespan of the device. Complications such as for example the slackening of the screws fixing posts to implants can be easily avoided with regular check-ups. If post screws need to be tightened, this must be done by the practitioner, using suitable instruments with control over tightening torque. The calibration of these instrument should be checked regularly.

If patients become aware that maintenance may be required, they should contact their practitioner as soon as possible, so that the necessary work to restore correct orthodontic functionality can be carried out. Delays in consulting the practitioner may lead firstly to the fracture of the connection screw or of the prosthesis, and secondly to the loss of the implant, thereby compromising rehabilitation results. Practitioners must make this clear to their patients. Complications may be biological (impaired integration) or mechanical (fracture of a component due to excessive loads). If there are no complications, the lifespan of devices and of the entire prosthetic apparatus depends on its mechanical resistance according to the fatigue that accumulates in the device. Any decementation of definitively cemented crowns or bridges that may allow impact shocks to be transmitted to implant structures may cause fractures to these structures. Sweden & Martina SpA has subjected implant/post/connection screw assemblies to the required cycle of 5,000,000 fatigue resistance tests. The assemblies passed these tests with positive results. The fatigue resistance tests were carried out in compliance with specific requirements, and were further validated using finite element calculations.

Cleaning / sterilization / conservation of prosthetic components and instruments

Caution!!! All prosthetic components and instruments for dental implants are supplied as NON-STERILE. Before use, all devices must be cleaned, disinfected and sterilized using the following procedures validated by Sweden & Martina SpA. These procedures must be performed before intraoral use of the devices, meaning before every use in testing and trial operations and compulsorily before definitive prosthetic loading. The repetition of the processes described in this sections does not modify the characteristics of these devices. Failure to follow these instructions may cause cross-infections.

a. Cleaning: Containers and transports used for washing: no special requirements.

In case of automated cleaning, use an ultrasound bath with a suitable detergent solution (e.g. DURR ID212, DC1 or equivalent). The concentration of the solution and duration of washing must comply with the manufacturer's instructions. Use demineralized water to avoid the formation of stains and marks. When draining washing water, check that all residues have been removed from devices, holes, etc. If necessary, repeat the cycle or clean manually.

In case of manual cleaning, use a suitable detergent (e.g. DURR ID212, DC1 or equivalent), following the manufacturer's instructions. Brush the products with a soft-bristled brush under abundant running water. Using the brush, apply the detergent to all surfaces. Rinse with distilled water for at least four minutes. Ensure that the running water passes abundantly through any holes and other openings. After rinsing, thoroughly dry the components and pack them in appropriate sterilization bags.

If a drying process is carried out, it must not exceed 120°C.

b. Sterilization: In a vacuum autoclave, sterilizing as follows:

- autoclave (gravity displacement cycle) at a temperature of 121°C with minimum exposure of 30 minutes and drying cycle of 15 minutes;
- autoclave (dynamic air removal cycle) at the temperature of 132–134°C with minimum exposure of 5 minutes and drying cycle of 20 minutes.

c. Conservation: After sterilization, products must remain in the bags used for sterilization. Bags must only be opened immediately before use. In normal conditions, sterilization bags are usually able to maintain the sterility of their contents, unless the wrapping is damaged. Do not therefore use components if the bags in which they were kept are damaged, and resterilize them in new bags before using again. The storage time of products sterilized in bags must not exceed the time recommended by the manufacturer of the bags.

Products must be stored in a cool and dry place, away from sunlight, water and heat sources.

Cleaning, sterilization and storage of the CRI5 torque-control ratchet wrench

The processes described below must be performed before the first use and before each subsequent operation. The repetition of the processes described in this section does not significantly modify the characteristics of these devices.

Failure to follow these instructions may cause cross-infections. Containers and transports to be used for washing: no special requirements.

As soon as possible after each use, the ratchet must be placed in a container filled with a disinfectant/cleansing solution and totally covered with a cloth. This prevents the drying out and dissolution of contaminants from the patient, making later cleaning easier and more effective. Totally dismantle the ratchet as indicated below:

Completely unscrew the torque adjustment screw and remove the spring inside the ratchet body handle. Do not separate the spring from the pin that acts as a stop.



Use the hexagonal tip at the end of the torque adjustment screw to unscrew and completely extract the tightening screw of the cover on the side marked OUT. Use only light pressure to avoid damaging the hexagonal tip.



After removing the cover, extract the toothed ratchet wheel and the wheel lock from inside the head of the ratchet.



In case of manual cleaning, clean the outer and inner surfaces of the instrument mechanically under hot water with a soft bristle brush. Rinse the difficultly accessible holes of the head and the area around the ratchet wheel and the wheel lock by injecting hot water with a needleless syringe. If necessary, proceed in the same way for the inside of the handle and of the torque adjustment device. Use a suitable neutral detergent and follow the manufacturer's instructions. Using the brush, apply the detergent to all surfaces. Rinse with distilled water for at least four minutes. Make sure the running water passes abundantly through the passages. In case of automated ultrasound cleaning, use an ultrasound bath with a suitable detergent solution. Use only neutral detergents. Follow the manufacturer's instructions for detergent concentrations and washing times. Use demineralized water to avoid the formation of stains and marks. During this operation, avoid contact between components, as this causes the deterioration of machined surfaces, and consequently the loss of precision in the torque measurements. When draining washing water, check that all residues have been removed from devices, holes, etc. If necessary, repeat the operation or clean manually.

NB: Residues of blood and other deposits reduce the effectiveness of the sterilization process, and it is therefore essential to clean the ratchet thoroughly. During cleaning operations, avoid splashes or sprays of liquids, and always work wearing suitable protection equipment. Avoid contact between this instrument and other nickel-plated instruments. Components must be reassembled before sterilization. Dry the components, lightly lubricate functional areas and reassemble the ratchet as shown in the illustrations below. Excessive lubricant may spread to the surface of the instrument during sterilization. Use only the lubricant supplied.

After lubricating the parts shown in the illustration, insert the two components of the ratchet head, with first the ratchet wheel and then the wheel stop.



Lubricate the contact areas between the ratchet wheel and the pin of the wheel stop.



After inserting and lubricating components 2 and 3 in the head of the ratchet, position the cover and turn the ratchet from the side mark OUT. Tighten the screw with the hexagonal tip of the torque adjustment screw.



Lubricate the spring inside the ratchet handle. Assemble the torque adjustment screw, checking the instrument for correct operation and manually activating the ratchet wheel.



Sterilization: In a vacuum autoclave, proceeding as follows:

Temperature = 121–124°C, with a minimum autoclave cycle of 20 minutes and a drying cycle of 15 minutes.

This procedure is essential to maintain the precision of the instrument within a tolerance range of ± 3.5 Ncm. Operate the torque and insertion mechanism to check for correct functioning. Remove all traces of lubricant from the external surfaces of the ratchet. Place the device in a suitable sterilization bag. Disassembly and reassembly operations must be carried out following the instructions provided.

Responsibility for defective products and warranty terms

Optimal care of the patients and attention to their needs are necessary conditions for the success of implant procedures, and they must therefore be carefully selected and informed of the associated risks and obligations associated with the treatment, and encouraged to cooperate with the dentist to ensure the success of the treatment. The patient must therefore practice good oral hygiene, which should be confirmed during regular check-ups. This must always be verified and documented, and similarly, all indications and instructions must also be observed and documented. The warranty covers manufacturing defects only, on condition that the faulty product is identified by the article code and batch number and returned within the period of validity of the warranty.



The guarantee terms are accessible at
www.sweden-martina.com

Warning – Limitations of guarantee

The prosthetic components manufactured by Sweden & Martina are intended for use with dental implants and prosthetic instruments also manufactured by Sweden & Martina. The use of non-original components limits the liability of Sweden & Martina SpA and invalidates the product guarantee.

The prosthetic components must be screwed onto implants using specific instruments. It is advisable to use only instruments manufactured by Sweden & Martina for screwing operations. No liability can be accepted if non-original instruments are used.











The instruments manufactured by Sweden & Martina are intended for use with dental implants and prosthetic components also manufactured by Sweden & Martina.

The use of instruments for operations with implants other than those manufactured by Sweden & Martina limits the liability of Sweden & Martina and invalidates the product guarantee. No liability can be accepted if non-original instruments are used.

Disposal

If removed from the oral cavity due to biological or mechanical failure, prosthetic components must be disposed of as biological wastes. Instruments are made from small components, usually in metal. They may therefore be disposed of as metal wastes. If dirty, they must be disposed of as biological wastes. In general, local regulations on waste disposal must be followed.

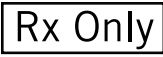
Key to symbols used on implant packs

description	code
Caution! See instructions for use	
Batch number	
Code	
Non-sterile product (only prosthetic components and surgical instruments)	
Disposable product, do not reuse	
Manufacturer	
Consult instructions for use	
CE conformity mark for class 1 products	
CE conformity mark for class 2a and 2b products	
American federal law restricts this device to sale by or by order of a professional practitioner	
Non-sterilizable	

This manual was last updated in September 2015.

- Bengazi F, Lang NP, Caroprese M, Velez JU, Favero V, Botticelli D; Dimensional changes in soft tissues around dental implants following free gingival grafting: an experimental study in dogs; *Clinical Oral Implant Research* 26, 176–182, 2015, doi: 10.1111/clr.12280
- Micarelli C, Canullo L, Giuliano I.; Implant/abutment connection deformation after prosthetics procedures – an in vitro study ; *International Journal of Prosthodontics*, 1-9,2014, Early view in ahead of print, accepted July 21st, 2015 doi to be attributed
- Peñarrocha-Oltra D, Covani U, Peñarrocha M, Peñarrocha-Diago M.; Immediate versus conventional loading with fixed full-arch prostheses in mandibles with failing dentition: a prospective controlled study; *International Journal of Oral and Maxillofacial Implants* 30, 2015:427–434; doi: 10.11607/jomi.3534
- Prati C, Zamparini F, Ciulla A, Buonavoglia A, Gatto MR, Piattelli A, Gandolfi MG; Evaluation of marginal bone level of Premium implants; XXIII Congress SIO, Milano 6-7 febbraio Poster; 2015
- Gandolfi MG, Siboni F, Piattelli A, Prati C; Nano-topography, microchemical properties and calcium phosphate nucleation of Premium implants;30th Annual Congress, American Academy of Osseointegration, San Francisco, 12-14 March Poster , 2015 Id 2088727
- Guazzotti PP; Carico immediato di impianti post estrattivi: presentazione di un caso clinico full-arch; *Doctor Os*, XXVI, 01, gennaio 24-29 ; 2015
- Penarrocha-Oltra D, Rossetti PHO, Covani U, Galluccio F, Canullo L; Microbial leakage at the implant/abutment connection due to implant insertion maneuvers: cross-sectional study 5 years post loading in healthy patients.; *Journal of Oral Implantology*, accepted for publication January 2015
- Agustín-Panadero R., Serra-Pastor B., Chust-López C., Fons-Font A., Ferreira A. ; Immediate placement of single implant simultaneously with immediate loading in a fresh socket associated to periapical infection: A clinical case report; *Journal of Clinical and Experimental Dentistry*. ;7(1), 2015:175-9
- Canullo L., Peñarrocha-Oltra D., Covani U., Botticelli D., Serino G., Peñarrocha M.; Clinical and microbiological findings in patients with peri-implantitis: a cross-sectional study; *Clinical Oral Implant Research*, 00, 1-7,2015 ; doi: 10.1111/clr.12557
- Mainetti T, Lang NP, Bengazi F, Favero V, Soto Cantero L, Botticelli D; Sequential healing at implants installed immediately into extraction sockets. An experimental study in dogs; *Clinical Oral Implant Research*, 00, 1-9, 2014, doi: 10.1111/clr.12533
- Beolchini M, Lang NP, Gomez Moreno G, Iezzi G, Botticelli D, Calvo Guirado JL; Bone healing at implants with different surface configuration: an experimental study in dogs; *Clinical Oral Implant Research* 00, 1-7, 2015, doi: 10.111/clr.12562
- Borgia V, Alfonsi F, Toti P, Tonelli P, Covani U, Barone A; Immediate restoration of post-extraction implants. A 7 years prospective single cohort study.; 30th Annual Congress, American Academy of Osseointegration, San Francisco, 12-14 March Poster ; 2015
- Kern JS, Kern T, Wolfart S, Heussen N; A systematic review and meta-analysis of removable and fixed implant-supported prostheses in edentulous jaws: post-loading implant loss; *Clinical Oral Implant Research*, 00, 1-22, 2015, doi: 10.1111/clr.12531
- Crespi R, Bruschi GB, Gastaldi G, Cappare P, Gherlone EF ; Immediate loaded implants in split-crest procedure; *Clin Implant Dent Relat Res.*, Mar 17. 2015 doi: 10.1111/cid.12316
- Martín Anciburo Miguel Ángel; Rehabilitación unitaria implantosortada utilizando la técnica B.O.P.T.; *Numeri Uno* 04, 2015: 11-14
- Requena Gómez E, ,Cervantes Haro MN, Aragonese Lamas JM ; ¿Es la cirugía guiada junto a la carga inmediata una técnica predecible? A propósito de un caso clínico; *Numeri Uno* 04, 2015: 16-19
- Canullo L, Peñarrocha-Oltra D, Marchionni S, Bagán L, Peñarrocha-Diago MA, Micarelli C.; Soft tissue cell adhesion to titanium abutments after different cleaning procedures: Preliminary results of a randomized clinical trial.; *Medicina Oral y Patología Oral Cirurgia Bucal*, published on line 2013 Oct 13, 2014 Mar 1;19(2): el 77-83, doi: 10.4317/medoral.19329
- Pellicer-Chover H, Peñarrocha-Oltra D, Bagán L, Fichy-Fernandez AJ, Canullo L, Peñarrocha-Diago M; Single blind randomized clinical trial to evaluate clinical and radiological outcomes after one year of immediate versus delayed implant placement supporting full-arch prosthesis; *Medicina Oral y Patología Oral Cirurgia Bucal*, 1; 19(3), 2014: 295-301, doi: 10.4317/medoral.19536
- Crespi R, Cappare P, Polizzi E, Gherlone E; Fresh-socket implants of different collar length: Clinical evaluation in the aesthetic zone; *Clinical Implant Dentistry and Related research*, 00, 2014 : 1-8, early view in ahead of print, first published on line 7 Feb 2014 doi 10.1111/cid.12202
- Negri B, López Mari M, Maté Sánchez de Val JE, Iezzi G, Bravo González LA, Calvo Guirado JL; Biological width formation to immediate implants placed at different levels in relation to the crestal bone – an experimental study in dogs; *Clinical Oral Implant Research*, 00, 2014: 1-11, Early view in ahead of print, accepted 06 January 2014 doi 10.1111/clr.12345,
- Strietzel FP, Neumann K, Hertel M ; Impact of platform switching on marginal peri-implant bone-level changes. A systematic review and meta-analysis; *Clinical Oral Implant Research*, 00, 2014: 1-16, Early view in ahead of print, accepted 11 December 2013, doi 10.1111/clr.123339
- Peñarrocha-Oltra D, Candel-Marti E, Peñarrocha-Diago M, Agustín-Panadero R, Canullo L, Peñarrocha M; The Horizontal Denture®: a prosthodontic alternative for Severe Maxillary Atrophy. A technical note; *Journal of Oral Implantology*, Early view in ahead of print, accepted 8 January 2014, 2014
- Maiorana C, Farronato D, Pieroni S, Ciccì M, Andreoni D, Santoro F; A four-year survival rate multicenter prospective clinical study on 377 implants – correlations between implant insertion torque, diameter and bone quality; *Journal of Oral Implantology*, 2014, Early view in ahead of print, accepted 11 February 2014
- Canullo L, Peñarrocha-Oltra D, Soldini C, Mazzocco F, Peñarrocha M, Covani U; Microbiological assessment of the implant-abutment interface in different connections: cross-sectional study after 5 years of functional loading; *Clinical Oral Implant Research*, 00, 2014: 1-9, Early view in ahead of print, accepted 22 February 2014, doi 10.1111/clr.12383,
- Mainetti T, Lang N, Bengazi F, Sbricoli L, Soto Cantero L, Botticelli D.; Immediate loading of implants installed in a healed alveolar bony ridge or immediately after tooth extraction: an experimental study in dogs; *Clinical Oral Implant Research*, 00, 2014: 1-8, Early view in ahead of print, accepted 5 March 2014, doi 10.1111/clr.12389
- Engelhardt S, Papacosta S, Rathe F, Ozen J, Jansen J.A., Junker R.; Annual failure rates and marginal bone-level changes of immediate compared to conventional loading of dental implants. A systematic review of the literature and meta-analysis; *Clinical Oral Implant Research*, 00, 2014: 1-17, Early view in ahead of print, accepted 9 February 2014, doi 10.1111/clr.12363,
- Bruschi GB, Crespi R, Cappare P, Grande N, Bruschi E, Gherlone E; Radiographic evaluation of crestal bone levels of delayed implants at5 medium term follow up; *International Journal of Oral & Maxillofacial Implants*, 29;2014: 441-447 doi 10.11607/jomi.3254
- Sbordone C, Toti P, Martuscelli R, Guidetti F, Sbordone L, Ramaglia L; A 5-year implant follow-up in maxillary and mandibular horizontal osseous onlay grafts and native bone; *Journal of Oral Implantology*, Early view in ahead of print, accepted 4 March 2014; 2014
- Canullo L, Micarelli C, Bettazzoni L, Magnelli A, Baldissara P; Shear bond strength of veneering porcelain to zirconia after argon plasma treatment; *International Journal of Prosthodontics*, Mar-Apr, 27(2), 2014: 137-9, 2014 doi: 10.11607/ijp.3722
- Canullo L, Micarelli C, Bettazzoni L, Koçi B, Baldissara P; Zirconia-Composite bonding after plasma of argon treatment; *International Journal of Prosthodontics*, 27:267-269, 2014, doi: 10.11607/ijp.3686
- Peñarrocha-Oltra D, Peñarrocha-Diago M, Canullo L, Covani U, Peñarrocha Miguel; Patient-reported outcomes of immediate versus conventional loading with fixed full-arch prostheses in the maxilla: a non-randomized controlled prospective study; *The International Journal of Oral & Maxillofacial Implants*, 29 (3), 690-698; 2014
- Covani U, Canullo L, Toti P, Alfonsi F, Barone A; Tissue stability of implants placed in fresh extraction sockets – a 5 year prospective single cohort study; *Journal of Periodontology*, 85: 323-332, 2014, doi 10.1902/jop2014.140175
- De Santis E, Lang NP, Favero G, Beolchini M, Morelli F, Botticelli D.; Healing at mandibular block-grafted sites. An experimental study in dogs; *Clinical Oral Implant Research*, 00, 2014: 1-7, Early view in ahead of print, accepted 17 May 2014, doi 10.1111/clr.12434,
- Crespi R, Bruschi GB, Cappare P, Gherlone E.; The utility of the electric mallet; *The Journal of Craniofacial Surgery*, 25 May (3), 793-795, 201, 2014, doi 10.1097/SCS.0000000000000523;2014
- Covani U, Marconcini S, Ferrini F, Gelpi F, Finotti M, Barone A.; Post-traumatic use of dental implants immediately after tooth extraction – clinical study; *The Journal of Craniofacial Surgery*,

- 25 May (3), 796-798, 2014, doi 10.1097/SCS.0000000000000522
- Calesini G, Zarone F, Sorrentino R, Micarelli C, Fabianelli A, Papacchini F, Gherlone E.; Effect of 2 impression techniques on the dimensional accuracy of working implant prosthesis models - an in vitro study; *The Journal of Craniofacial Surgery*, 25 May (3), 822-827, 2014, doi 10.1097/SCS.0000000000000715
 - Quaranta A, Andreana S, Pompa G, Procaccini M; Active implant peri-apical lesion - a case report treated via guided bone regeneration with a 5-year clinical and radiographic follow-up; *Journal of Oral Implantology*, 40 (3), 313-319, 2014, doi: 10.1563/AAL.JOI.D.11.00214
 - J. Viña-Almunia ; Microbial colonization of the implant connection with cemented versus screw-retained suprastructures; Oral presentation ,Clinical research - Prosthetically oriented - EAO Congress, Rome 25-27 September 2014, *Clinical Oral Implant Research*, 25 (suppl. 10), 93, 2014
 - Cocchetto R.; Improved cementation technique for implant restorations to avoid periimplant cement remnants: clinical and microscopical evaluation with two different abutment design; Oral presentation, Clinical research - Prosthetically oriented - EAO Congress, Rome 25-27 September 2014, *Clinical Oral Implant Research*, 25 (suppl. 10), 96; 2014
 - Augustín-Panadero R, Serra-Pastor B, Roig-Vanaclocha A, Román-Rodríguez JL, Fons-Font A; Mechanical behavior of provisional implant prosthetic abutments; *Medicina Oral Patología Oral y Cirugía Bucal*, 1-9, 2014, Early view in ahead of print, accepted July 2014, doi 10.4317/medoral.19958,
 - Micarelli C, Canullo L, Giuliano I.; Implant/abutment connection deformation after prosthetics procedures - an in vitro study ; *International Journal of Prosthodontics*, 1-9,2014, Early view in ahead of print, accepted July 21st, 2015 doi to be attributed
 - Kinaia BM, Shah M, Neely AL, Goodies HE; Crestal bone level changes around immediately placed implants - A systematic review and meta-analyses with at least 12 months follow up after functional loading; *Journal of Periodontology*, 2014, early view in ahead of print, doi: 10.1902/jop2014.130722;2014
 - Cicciù M, Bramanti E, Matakca G, Guglielmino E, Risitano G.; FEM evaluation of cemented-retained versus screw-retained dental implant single-tooth crown prosthesis; *International Journal of Clinical and Experimental Medicine* 7(4) , 2014: 817-825; doi: 1940-5901.ijcem.1402025
 - Crespi R, Capparè P, Polizzi EM, Gherlone EF.; Tissue remodeling after bone expansion in grafted and ungrafted sockets; *The International Journal of Oral and Maxillofacial Implants*, 29, 2014: 699-704, , doi: 10.11607/jomi.3535
 - Bruschi GB, Crespi R, Capparè P, Gherlone E.; Clinical Study of flap design to increase the keratinized gingiva around implants - a 4 year follow-up; *Journal of Oral Implantology*, 40(4) , 2014: 459-464, doi: 10.1563/aid-joi-d-11-00236
 - Romanos GR, Javed F.; Platform switching minimises crestal bone loss around dental implants - truth or myth?;*Journal of Oral Rehabilitation*, 2014, early view in ahead of printing, accepted for publication 30 April 2014, doi 10.1111/joor.12189
 - Gaspari L.; Tecnica conometrica con provvisorio elettrosaldato per carico immediato; *Italian Dental Journal*, agosto, 29; 2014
 - Lumetti S, Galli C, Smerieri A, Macaluso G, Manfredi E, Ghiacci G, Di Blasio A, Megri M.; The effect of age, gender and insertion site on marginal bone loss around endosseous implants: results for a 3 year trial; Poster, EAO Congress, Rome 25-27 September 2014, *Clinical Oral Implant Research*, 25 (suppl. 10), 440; 2014
 - Lumetti S, Di Blasio A, Manfredi E, Ghiacci G, Toffoli A, Bonanini M, Macaluso G, Galli C.; Implant surface microtopography affects the patten of cell growth, cell-to-cell contacts and the expression of Connexin 43;Poster, EAO Congress, Rome 25-27 September 2014, *Clinical Oral Implant Research*, 25 (suppl. 10), 222; 2014
 - Caneva M, Lang NP, Calvo Guirado JL, Spriano AM, Iezzi G, Botticelli D.; Bone healing at bicortically installed implants with different surface configurations. An experimental study in rabbits; *Clinical Oral Implant Research*, 00, 2014: 1-7, Early view in ahead of printing, accepted 29 July 2014, doi:10.1111/clr.12475
 - D'Ercole S, Tripodi D, Marzo G, Bernardi S, Continenza MA, Piattelli A, Iaculli F, Mummolo S.; Microleakage of bacteria in different implant-abutment assemblies: an in vitro study; *Journal of Applied Biomaterial and Functional Materials*, 2014, accepted June 12, 2014, doi: 105301/jabfm.5000214
 - Peñarrocha-Oltra D, Peñarrocha-Diago M, Aloy-Prosper A, Covanu U, Peñarrocha M.; Immediate versus conventional loading of complete-arch implant-supported prostheses in mandibles with failing dentition: a patient centered controlled prospective study; *Journal of oral and Maxillofacial Implants*, submitted; 2014
 - Bowen Antolín A, Ariño B, Arlandi Garrido M.; Regeneración ósea periimplantaria con fosfato de calcio bifásico y ácido poliláctico;*Gaceta Dental*, 260(7), 2014: 174-186;
 - Morelli F, Lang NP, Bengazi F, Baffone D, Vila Morales CD, Botticelli D.; Influence of bone marrow on osseointegration in long bones: an experimental study in sheep; *Clinical Oral Implant Research*, 00, 1-7, 2014, Early view in ahead of printing, accepted 29 August 2014, doi:10.1111/clr.12487
 - Marchetti E, Ratta S, Mummolo S, Tecco S, Pecci R, Bedini R, Marzo G.; Evaluation of an endosseous oral implant system according to UNI EN ISO 14801 Fatigue Test Protocol; *Implant Dentistry*, 2014, Early View in ahead of print, doi: 10.1097/id.151
 - Negri M, Galli C, Smerieri A, Macaluso GM, Manfredi E, Ghiacci G, Toffoli A, Bonanini M, Lumetti S; The effect of age, gender and insertion site on marginal bone loss around endosseous implants: results from a 3-year trial with Premium Implant System; *BioMed research International*, Volume 2014, Article ID 369051, 7 pages, doi.org/10.1155/2014/369051
 - Esposito M, Ardebili Y, Worthington HV; Interventions for replacing missing teeth: different types of dental implants (Review);*The Cochrane Collaboration*, John Wiley and Sons, Ltd; 2014
 - Mainetti T, Lang NP, Bengazi F, Favero V, Soto Cantero L, Botticelli D; Sequential healing at implants installed immediately into extraction sockets. An experimental study in dogs; *Clinical Oral Implant Research*, 00, 1-9, 2014, doi: 10.1111/clr.12533
 - Crespi R, Capparè P, Gastaldi G, Gherlone EF; Immediate Occlusal loading of full-arch rehabilitations: screw-retained versus cement-retained prosthesis. An 8 year clinical evaluation; *International Journal of Oral & Maxillofacial Implants* 29, 2014:1406-1411; doi: 10.11607/jomi.3746
 - Pradies Ramiro G., Abad Coronel C., García Martínez I., Ferreira Navarro A.; Impresiones fiables: dos propuestas para un mismo objetivo; *Numeri Uno*, 01, 2014, 6-9
 - Machín Muñoz A.; Regeneración ósea y gingival en implantes inmediatos post-extracción; *Numeri Uno* 01 , 2014: 20-21
 - Loi I.; Riabilitazione implanto-protetica di elemento incisivo frontale con impianto Prama; *Numeri Uno* 20, 2014: 12-13
 - Loi I.; Riabilitazione implanto-protetica di ponte distale con impianti Prama; *Numeri Uno* 20, 2014: 14-15
 - Gorni F.; Riabilitazione di elemento singolo in zona estetica con impianto Prama RF; *Numeri Uno* 20, 2014: 16-17
 - Vedove F.; Riabilitazione di elemento singolo in zona estetica con impianto Prama; *Numeri Uno* 20, 2014: 18-19
 - Andreoni D.; Riabilitazione di elemento singolo in posizione 4.6 con impianto Prama; *Numeri Uno* 20, 2014: 20-21
 - Sandri L.P.; Utilizzo clinico dei nuovi impianti Prama: inserimento e riabilitazione con un singolo impianto; *Numeri Uno* 20, 2014: 22-24
 - Csonka M.; Trattamento implantologico delle creste sottili: Split Crest o GBR?; *Numeri Uno* 19, 2014: 12-14
 - Vischia F., Roncoroni F.; Ortodonzia protesica mediante tecnica B.O.P.T.; *Numeri Uno* 19, 2014: 19-21
 - Schirripa G., Schirripa F.; Carico immediato; *Numeri Uno* 19, 2014: 22-24
 - Baldi D., Colombo J., Pera P., Hauschild U.; Una tecnica minimamente invasiva: implantologia con utilizzo di impianti a diametro ridotto e tecniche CAD CAM per una provvisorizzazione a lungo termine; *Numeri Uno* 18, 2014: 6-9
 - Gaspari L.; Implantoprotesi conometrica elettrosaldato chairside a carico immediato - caso clinico; *Numeri Uno*, 18, 2014:12-14
 - Loi I.;Tecnica B.O.P.T. su denti e impianti per la riabilitazione di un'arcata completa; *Numeri Uno* 18 , 2014:21-22
 - Morandini E. ; La precisione nel Cr.Co. laser sinterizzato rivestito in ceramica; *NumeriUno* 17, 2013: 9-11 - *NumeriUno* 18, 2014: 16-19
 - Loi I.; Técnica B.O.P.T. sobre dientes naturales; *Numeri Uno* 02, 2014: 8-9
 - Loi I.;Técnica B.O.P.T. sobre dientes e implantes para la rehabilitación de los dos arcos completos;*Numeri Uno* 02, 2014 : 14
 - Canullo L, Cassinelli C, Goetz W, Tarnow D; Il plasma di argon accelera l'adesione dei fibroblasti murini nelle fasi precoci della colonizzazione di dischetti in titanio; *International Journal of Oral and Maxillofacial Implants* 2013; 28: 957-962. DOI: 10.11607/jomi.2664
 - Bengazi F, Botticelli D, Favero V, Perini A, Urbizo Velez J, Lang NP ; Influence of presence or absence of keratinized mucosa on the alveolar bony crest level as it relates to different buccal margin

- bone thicknesses. An experimental study in dogs; *Clinical Oral Implant Research*, 00, 2013, 1-7, Accepted 26 June 2013, first published on line on 29/07/2013, DOI 10.1111/clr.12233
- Peñarrocha-Oltra D, Covani U, Aparicio A, Ata-Ali J, Peñarrocha-Diago Miguel, Peñarrocha-Diago María; Immediate versus conventional loading for the maxilla with implants placed into fresh and healed extraction sites to support a full-arch fixed prosthesis: nonrandomized controlled clinical study; *International Journal of Oral and Maxillofacial Implants* 2013; 28: 1116-1124 DOI: 10.11607/jomi.3119
 - Covani U, Ricci M, Tonelli P, Barone A; An evaluation of new designs in implant-abutment connections: a finite element method assessment; *Implant Dentistry*, 2013, Jun22(3): 263-267, DOI 10.1097/ID.0b013e318292625f
 - Crespi R, Capparè P, Gherlone EF; Electrical mallet in implants placed in fresh extraction sockets with simultaneous osteotomy sinus floor elevation; *International Journal of Oral and Maxillofacial Implants*, 2013; 28(3): 869-874, doi: 10.11607/jomi.2679
 - Panadero RA, Fons Font A, Granell Ruíz M, Román Rodríguez JL, Solá Ruíz MF, Rubio Cebriá J; Sobredentadura implantosoportada de inserción horizontal; *Gaceta Dental*, 249: 100-112, 2013
 - Beolchini M, Lang NL, Viganò P, Bengazi F, Triana BG, Botticelli D; The edentulous ridge expansion (ERE) technique - an experimental study in dogs; *Clinical Oral Implant research*, 2013: 1-7, published on line early view in ahead of print in September 2013, doi: 10.1111/clr.12262
 - Bressan E., Lang NP, Corazza B, Rizzi S, Almagro Urrutia Z, Botticelli D; The Platform Switching concept revisited. An experimental study in dogs; *Clinical Oral Implant research*, 2013: 1-5, published on line early view in ahead of print in September 2013, doi: 10.1111/clr.12263
 - Crespi R, Capparè P, Gherlone EF; Electrical mallet provides essential advantages in split-crest and immediate implant placement; *Oral and Maxillofacial Surgery*, 2013, (18): published on line early view in ahead of print in January 2013, doi: 10.1007/s10006-013-0389-2
 - Canullo L, Peñarrocha-Oltra D, Marchionni S, Bagán L, Peñarrocha-Diago MA, Micarelli C.; Soft tissue cell adhesion to titanium abutments after different cleaning procedures: Preliminary results of a randomized clinical trial.; *Medicina Oral y Patología Oral Cirugía Bucal*, published on line 2013 Oct 13, 2014 Mar 1;19(2): el 77-83, doi: 10.4317/medoral.19329
 - Canullo L, Peñarrocha D, Peñarrocha M, Rocío A-G, Peñarrocha-Diago M.; Piezoelectric vs. conventional drilling in implant site preparation: pilot controlled randomized clinical trial with crossover design.; *Clinical Oral Implant Research* 00, 2013, 1-8, published on line early view in ahead of print in October 2013, doi: 10.1111/clr.12278
 - Micarelli C, Canullo L, Grusovin MG, Peñarrocha Oltra D; Cell adhesion to titanium abutments after different cleaning procedures; *Clinical Oral Implant Research*, 24(Suppl.9), 2013: 79-102
 - Canullo L, Peñarrocha D, Covani U, Micarelli C, Massidda O; Hard Tissue response to plasma of argon cleaning treatment on titanium abutments - 2 year follow-up RCT; *Clinical Oral Implant Research*, 24(Suppl.9), 27-47, 2013
 - De Risi V, Clementini M, Vittorini G, Mannocci A, De Sanctis M; Alveolar ridge preservation techniques: a systematic review and meta-analysis of histological and histomorphometrical data; *Clinical Oral Implant Research*, 00, 2013: 000-000, Early view in ahead of print, accepted September 2013, doi 10.1111/clr.12288,
 - Canullo L, Peñarrocha D, Clementini M, Iannello G, Micarelli C; Impact of plasma of argon cleaning treatment on implant abutments in patients with a history of periodontal disease and thin biotype - radiographic results at 24 months follow-up of a RCT; *Clinical Oral Implant Research*, 00, 2013: 000-000, Early view in ahead of print, accepted 18 September 2013, doi 10.1111/clr.12290
 - Canullo L, Peñarrocha D, Micarelli C, Massidda O, Bazzoli M; Hard tissue response to argon plasma cleaning / sterilization of customised titanium abutments versus 5-second steam cleaning: results of a 2-year post-loading follow-up from an explanatory randomized controlled trial in periodontally healthy patients; *European Journal of Oral Implantology*. Autumn; 6(3) .2013:251-60
 - Petrillo N.; Carico immediato full arch mascellare e mandibolare: un nuovo approccio chirurgico e protesico; *Il Dentista Moderno*, 2013 Novembre 2013: 82-96
 - Baffone G, Lang NP, Pantani F, Favero G, Ferri M, Botticelli D; Hard and soft tissue changes around implants installed in regular-sized and reduced alveolar bony ridges. An experimental study in dogs; *Clinical Oral Implant Research*, 00, Early view in ahead of print, accepted 28 October 2013: 1-6, doi 10.1111/clr.12306
 - Beolchini M, Lang NL, Ricci E, Bengazi F, Garcia Triana B, Botticelli D; Influence on alveolar resorption of the buccal bony plate width in the edentulous ridge expansion (E.R.E.) - an experimental study in the dog; *Clinical Oral Implant Research*, 00, 2013: 1-6, Early view in ahead of print, accepted 28 October 2013doi 10.1111/clr.12308
 - Strietzel FP, Neumann K, Hertel M; Impact of platform switching on marginal peri-implant bone-level changes. A systematic review and meta-analysis; *Clinical Oral Implant Research*, 00, 2014: 1-16, Early view in ahead of print, accepted 11 December 2013, doi 10.1111/clr.123339
 - Morandini E.; La precisione nel Cr.Co. laser sinterizzato rivestito in ceramica; *NumeriUno* 17, 2013: 9-11 - *NumeriUno* 18, 2014: 16-19
 - Sandri L.P.; Preparazione protesica mediante tecnica B.O.P.T.: caso clinico; *Numeri Uno* 17, 2013 :6-8
 - Corrente G., Abundo R., Greppi M., Perelli M., Villa A.; Posizionamento implantare e ricostruzione dei tessuti duri e molli: un protocollo semplificato; *Numeri Uno* 17, 2013:14-17
 - Avellino W., De Maria A., Milan U., Tamagnone L., Delle Rose D.; Direct Prosthetic Framework (D.P.F.); *Numeri Uno*, 17, 2013: 18-20
 - Figliuzzi M. M., De Fazio R., Tiano R., Scordamaglia F., Fortunato L.; Riabilitazione con impianto post-estrattivo immediato in zona estetica: Case Report; *Numeri Uno* 17, 2013:21-22
 - Fadda M.; Caso clinico con M.F. Extrusion; *Numeri Uno*, 17, 2013:26
 - Cardarelli F.; Effetti dentofacciali della terapia ortodontica in dentizione mista per la correzione delle II Classi; *Numeri Uno* 17, 2013: 28-31
 - Calesini G., Scipioni A.; Approccio rigenerativo sistematico finalizzato all'integrazione morfo-funzionale in implantopotesi; *Numeri Uno* 16, 2013: 6-9
 - Ponzi A.; Echo Plan: accuracy dell'implantologia guidata; *Numeri Uno* 16, 2013: 12-13
 - Canullo L., Cicchese P., Marinotti F.; Riabilitazione implanto-supportata di entrambi i mascellari edentuli con carico immediato; *Numeri Uno* 16, 2013: 14-15
 - Sisti A., Mottola M.P., Mottola P.; Riabilitazione bilaterale con chirurgia guidata; *Numeri Uno* 16, 2013: 16-18
 - Csonka M.; Split crest di una cresta molto sottile con il Magnetic Mallet; *Numeri Uno* 16, 2013: 22-23
 - Guidi R, Viscioni A, Dattola F, Carinci F; Dental implants inserted in native bone: cases series analyses; *Dental Research Journal*, 12(9), Issue 8 (Suppl Issue 2), 175-180; 2012
 - Canullo L, Cicchese P, Marinotti F; Valutazione di una procedura clinica e tecnica per la riabilitazione dei mascellari edentuli; *Il Dentista Moderno*, Marzo: 86-102, 2012
 - Canullo L, Cicchese P, Marinotti F, Sisti A; Strategia protesica minimamente invasiva negli impianti post-estrattivi: posizionamento e avvittamento immediato del moncone definitivo per protesi su impianti secondo il concetto del platform switching; *Il Dentista Moderno*, Dicembre: 46-54, 2011
 - Segura Andrés G., Martínez Lage J. F., Ferreira A., Faus Lòpez J., Agustín Panadero R.; Rehabilitación protésica en un maxilar atrófico a consecuencia de un trauma facial; *Gaceta Dental*, 2013; 244:112-118
 - Canullo L., Micarelli C., Clementini M.; Hard tissue response to argon plasma cleaning treatment on titanium abutments: 2-year follow-up RCT; *European Journal of Oral Implantology*, 6 (Suppl. Spring), 2013: S21-S22
 - Rossi F., Lang N. P., De Santis E., Morelli F., Favero G., Botticelli D.; Bone-healing pattern at the surface of titanium implants: an experimental study in the dog; *Clinical Oral Implant Research*, Early View, First Published online on 2013, January 4th; DOI: 10.1902/jop.2010.100428
 - Clementini M., Canullo L., Micarelli C.; Fibroblast growth on titanium disks treated by argon plasma: an in vitro triple-blinded study; *European Journal of Oral Implantology*, 6 (Suppl. Spring), 2013: S29-S30
 - Canullo L., Micarelli C., Iannello G.; Microscopical and chemical surface characterization of the gingival portion and connection of an internal hexagon abutment before and after different technical stages of preparation; *Clinical Oral Implant Research*, 2013, 24: 606-611; DOI: 10.1111/j.1600-0501.2012.02499.x

- Canullo L., Heinemann F., Gedrange T., Biffar R., Kunert-Keil C.; Histological evaluation at different times after augmentation of extraction sites grafted with a magnesium-enriched hydroxyapatite: double-blinded randomized controlled trial; *Clinical Oral Implant Research*, Early View, First Published online on 2013, January 4th; DOI: 10.1111/clr.12035
- Canullo L., Micarelli C., Clementini M., Carinci F.; Cleaning procedures on customized abutments: microscopical, microbiological and chemical analysis; *Clinical Oral Implant Research*, 2012; 23 Suppl 7: 55-56; DOI: 10.1111/clr.12019, 2012, 23(s7_128)
- Canullo L., Micarelli C., Lembo-Fazio L., Iannello G., Clementini M.; Microscopical and microbiologic characterization of customized titanium abutments after different cleaning procedures; *Clinical Oral Implant Research*, Early View, First Published online on 2012, December 5th, DOI: 10.1111/clr.12089
- Wennstrom J. L., Derks I.; Is there a need for keratinized mucosa around implants to maintain health and tissue stability?; *Clinical Oral Implant Research*, 2012; 23 Suppl 6: 136-146; DOI: 10.1111/j.1600-0501.2012.0254.x
- Sisti A., Canullo L., Mottola M. P., Covani U., Barone A., Botticelli D.; Clinical evaluation of a ridge augmentation procedure for the severely resorbed alveolar socket: multicenter randomized controlled trial, preliminary results; *Clinical Oral Implant Research*, 2012; 23: 526-535; DOI: 10.1111/j.1600-0501.2011.02386.x
- Sailer I., Muhlemann S., Zwahlen M., Hammerle C. H. F., Schneider D.; Cemented and screw-retained implant reconstructions: a systematic review of the survival and complication rates; *Clinical Oral Implant Research*, 2012; 23 Suppl 6: 163-201; DOI: 10.1111/j.1600-0501.2012.02538.x
- Barone A., Orlando B., Cingano L., Marconcini S., Derchi G., Covani U.; A randomized clinical trial to evaluate and compare implants placed in augmented vs. non-augmented extraction sockets A 3-year evaluation; *Journal of Periodontology*, 2012; 83: 836-846; DOI: 10.1902/jop.2011.110205
- Sisti A., Canullo L., Mottola M. P., Iannello G.; Crestal minimally invasive sinus lift on severely resorbed maxillary crest: prospective study; *Biomedizinische Technik/Biomedical Engineering*, 2012, 57, ISSN (Online) 1862-278X, ISSN (Print) 0013-5585; DOI: 10.1515/bmt-2011-0038
- Crespi C., Capparè P., Gherlone E.; Sinus floor elevation by osteotome: hand mallet versus electric mallet. A prospective clinical study; *The International Journal of Oral & Maxillofacial Implants*, 2012; 27: 1144-50; DOI: 10.1111/j.1708-8208.2012.00485.x
- Al-Nsour M., Chan H. L., Wang H. L.; Effect of the platform-switching technique on preservation of peri implant marginal bone: a systematic review; *International Journal of Oral and Maxillofacial Implants*, 2012; 27: 138-145
- Annibaldi S., Bignozzi I., Cristalli M. P., Graziani F., La Monaca G., Polimeni A.; Peri-implant marginal bone level: a systematic review and meta-analysis of studies comparing platform switching versus conventionally restored implants; *Journal of Clinical Periodontology*, 2012; 39: 1097-1113; DOI: 10.1111/j.1600-051X.2012.01930.x
- Csonka M.; Switching Platform chirurgico e protesico; *Italian Dental Journal*, 2012; 08: 24
- Lang N. P., Pun L., Lau K. Y., Li K. Y., Wong M. C.; A systematic review on survival and success rates of implants placed immediately into fresh extraction sockets after at least 1; *Clinical Oral Implants Research*, 2012; 23 (Suppl 5): 39-66; DOI: 10.1111/j.1600-0501.2011.02372.x
- Ortega Martinez J., Pérez Pascual T., Mereque Bueno S., Hernández Alfaro F., Ferrés Padró E.; Immediate Implants following tooth extraction - A systematic review; *Medicina Oral Patología Oral y Cirugía Bucal*, 2012; 17: 251-261; DOI: 10.4317/medoral.17469
- Vignoletti F., Morante Mudarra S., Lorenzo Vignau R., Oteo Pérez A., Rodrigo Gómez D.; "Implantes inmediatos en alveolos post-extracción. Factores críticos en la cicatrización de los tejidos duros y blandos"; *Maxillaris. Ciencia y Actualidad Profesional e Industrial del Sector Dental*, 2012, XV, 155: 110-126
- Bruschi G., Crespi R., Capparè P., Gherlone E.; Clinical study of flap design to increase the keratinized gingiva around implants. 4-year, follow-up; *Journal of Oral Implantology*, Early View, First published online in 2012, November; DOI: 10.1563/AAID-JO-ID-11-00236.1
- Canullo L., Gotz W.; Peri-implant hard tissue response to glow-discharged abutments: Prospective study. Preliminary radiological results; *Annals of Anatomy*, 2012; 194: 174-478; DOI: org/10.1016/j.aanat.2012.03.006
- Canullo L., Micarelli C., Clementini M.; Effect of titanium abutment plasma cleaning on peri-implant bone level changes: randomized controlled trial, preliminary results; Poster, Winner, Prize Martignoni, AIOF Congress Bologna, 22-24 Novembre 2012
- Bastieri A.; espansione ossea controllata con Drill Bone Expander (D.B.E.): variabili e polifunzionalità; *Numeri Uno* 15, 2013, 10-12
- Scavia S.; Studio prospettico sul mantenimento del volume osseo verticale in impianti inseriti con tecnica M.I.S.E.; *Numeri Uno* 14, 2012, 14-15
- Crespi R., Bruschi G. B.; Vantaggi chirurgici nell'uso del Magnetic Mallet; *Numeri Uno* 13, 2012, 16-18.
- Csonka M.; Postestrativo a carico immediato con Tecnica Simple e Platform Switching; *Numeri Uno* 12, 2012, 8-9
- Minenna F., De Leo L.; Riabilitazione impianto protesica con tecnica One Stage e protesi avvitata in materiale composito; *Numeri Uno*, 12; 2012, 12-13
- Micarelli C., Canullo L., Baldissara A., Clementini M.; Abutment screw removal torque values before and after plasma cleaning; *Clinical Oral Implant Research*, 2012; 23 Suppl 7: 72; DOI: 10.1111/clr.12019, 2012, 23(s7_162)
- Micarelli C., Canullo L., Baldissara P., Clementini M.; Abutment screw reverse torque values before and after plasma cleaning; *International Journal of Prosthodontics*, Accepted and Overview Published online, on 2012, September, 12th
- Peñarrocha Diago M., Pellicer Chover H., Peñarrocha Oltra D.; Rehabilitación con prótesis fija de arco completo maxillary mandibular sobre implantes postextracción. A propósito de un caso; *Numeri Uno* 11, 2012, 15-17
- Galli C., Piemontese M., Meikle S. T., Santin M., Macaluso G. M., Passeri G.; Biomimetic coating with phosphoserine-tethered poly(epsilon-lysine) dendrons on titanium surfaces enhances Wnt and osteoblastic differentiation; *Clinical Oral Implant Research*, Early View, First Published online on 2012, December 5th; DOI: 10.1111/j.1600-0501.2011.02227.x
- Bengazi F., Lang N. P., Canciani E., Viganò P., Urbizo Velez J., Botticelli D.; Osseointegration of implants with dendrimers surface characteristics installed conventionally or with Piezosurgery®. A comparative study in the dog; *Clinical Oral Implant Research*, Early View, First Published online on 2012, December 12th; DOI: 10.1111/clr.12082
- Schweikert M., Baffone G., Botticelli D., Favero G., Lavia P. P., Lang N. P.; Influence of buccal bony crest width on marginal dimensions of peri-implant tissues after implant installation in dogs; *Clinical Oral Implant Research*, 2012; 23 Suppl 7: 77-78; DOI: 10.1111/clr.12019, 2012, 23(s7_171)
- Baffone G. M., Botticelli D., Pereira F. P., Favero G., Schweikert M., Lang N. P.; Influence of buccal bony crest width on marginal dimensions of peri-implant hard and soft tissues after implant installation. An experimental study in dogs; *Clinical Oral Implants Research*, 2013; 24: 250-254; DOI: 10.1111/j.1600-0501.2012.02512.x
- Crespi R., Capparè P., Gherlone E.; A comparison of manual and electrical mallet in maxillary bone condensing for immediately loaded implants: a randomized study; *Clinical Implant Dentistry and Related Research*, Early View, First Published online on 2012, August, 15th, DOI: 10.1111/j.1708-8208.2012.00485.x
- Calvo-Guirado J. L., Boquete-Castro A., Negri B., Delgado Ruiz R., Gomez-Moreno G., Iezzi G.; Crestal bone reactions to immediate implants placed at different levels in relation to crestal bone. A pilot study in foxhound dogs; *Clinical Oral Implant Research*, Early View, First Published online on 2013, January 25th; DOI: 10.1111/clr.12110
- Scala A., Lang N. P., Schweikert M. T., de Oliveira J. A., Rangel-Garcia I. Jr, Botticelli D.; Sequential healing of open extraction sockets. An experimental study in monkeys; *Clinical Oral Implant Research*, Early View, First Published online on 2013, April 1st; DOI: 10.1111/clr.12148
- Rossi F., Lang N. P., Favero G., Pantani F., Tschon M., Botticelli D.; Bone healing pattern at the surface of titanium implants: an experimental study in the dog; *Clinical Oral Implant Research*, 2012; 23 Suppl 7: 76-77; DOI: 10.1111/clr.12019, 2012, 23(s7_171)
- Sivoletta S., Bressan E., Salata L. A., Urrutia Z. A., Lang N. P., Botticelli D.; Osteogenesis at implants without primary bone contact - An experimental study in dogs; *Clinical Oral Implant Research*, 2012; 23: 542-549, DOI: 10.1111/j.1600-0501.2012.02423.x
- Sivoletta S., Bressan E., Salata L. A., Quiñones M. E., Urrutia Z. A., Lang N. P., Botticelli D.; Deproteinized bovine bone mineral particles and osseointegration of implants without primary

- bone contact: an experimental study in dogs; *Clinical Oral Implant Research*, Early View, First Published online on 2013, April 8th; DOI: 10.1111/clr.12154
- Caneva M., Botticelli D., Viganò P., Morelli F., Rea M., Lang N. P.; Connective tissue grafts in conjunction with implants installed immediately into extraction sockets. An experimental study in dogs; *Clinical Oral Implant Research*, 2013; 24: 50-56; DOI: 10.1111/j.1600-0501.2012.02450.x
 - De Santis E., Lang N. P., Cesaretti G., Mainetti T., Beolchini M., Botticelli D.; Healing outcomes at implants installed in sites augmented with particulate autologous bone and xenografts. An experimental study in dogs; *Clinical Oral Implants Research*, 2013; 24: 77-86; DOI: 10.1111/j.1600-0501.2012.02456.x
 - Negri M., Lumetti S., Manfredi E., Galli C., Chiacci G., Macaluso G. M.; Marginal bone remodelling of Sweden&Martina Premium implants: 2-years clinical results; *Clinical Oral Implant Research*, 2012; 23 Suppl 7: 98; DOI: 10.1111/clr.12019, 2012, 23(s7_218)
 - Cosyn J., Hooghe N., De Bruyn H.; A systematic review on the frequency of advanced recession following single Immediate Implant treatment; *Journal of Clinical Periodontology*, 2012 Jun; 39: 582-589; DOI: 10.1111/j.1600-051X.2012.01888.x
 - Covani U., Chiappe G., Bosco M., Orlando B., Quaranta A., Barone A.; A 10-year evaluation of implants placed in fresh extraction sockets: a prospective cohort study; *Journal of Periodontology*, 2012; 83: 1226-1234; DOI: 10.1902/jop.2012.110583
 - Covani U., Ricci M., D'Ambrosio N., Quaranta A., Barone A.; Changes in soft tissues around immediate full-arch rehabilitations: a prospective study; *Clinical Oral Implant Research*, Early View, First Published online on 2012, January, 6th; DOI: 10.1111/j.1600-0501.2011.02394.x
 - Crespi R., Capparè P., Gherlone E., Romanos G.; Immediate provisionalization of dental implants placed in fresh extraction sockets using a flapless technique; *The International Journal of Periodontics & Restorative Dentistry*, 2012; 32: 29-37
 - Morelli F.; Rigenerazione ossea orizzontale e verticale peri-implantare con mesh in Titanio ed osso autologo; *Numeri Uno* 11; 2011, 7-9
 - Crespi R., Capparè P., Gherlone E.; Electrical mallet provides essential advantages in maxillary bone condensing. A prospective clinical study; *Clinical Implant Dentistry and Related Research*, Early View, First Published online on 2012, January, 11th; DOI: 10.1111/j.1708-8208.2011.00432.x
 - Galli C., Macaluso G.M., Elezi E., Ravanetti F., Cacchioli A., Gualini G., Passeri G.; The Effects of Er:YAG Laser Treatment on Titanium Surface Profile and Osteoblastic Cell Activity: An In Vitro Study; *Journal of Periodontology*, 82 (8): 1169-1177, 2011; DOI: 10.1902/jop.2010.100428
 - Ramaglia L., Postiglione L., Di Spigna G., Capece G., Salzano S., Rossi G.; Sandblasted-acid-etched titanium surface influences in vitro the biological behavior of SaOS-2 human osteoblast-like cells; *Dental Material Journal*, 30: 183-192, 2011; DOI:10.4012/dmj.2010-107
 - Scala A., Botticelli D., Faeda R.S., Rangel I.G. Jr., de Oliveira J.A., Lang N.P.; Lack of influence of the Schneiderian membrane in forming new bone apical to implants simultaneously installed with sinus floor elevation: an experimental study in monkeys; *Clinical Oral Implant Research*, Early View, First Published online on 2011, June 13th; DOI: 10.1111/j.1600-0501.2011.02227.x
 - Rossi F., Botticelli D., Pantani F., Pereira F.P., Salata L.A., Lang N.P.; Bone healing pattern in surgically created circumferential defects around submerged implants: an experimental study in dog; *Clinical Oral Implant Research*, Early View, First Published online on 2011, March 28th; DOI: 10.1111/j.1600-0501.2011.02170.x
 - Caneva M., Botticelli D., Pantani F., Baffone G.M., Rangel I.G. Jr., Lang N.P.; Deproteinized bovine bone mineral in marginal defects at implants installed immediately into extraction sockets: an experimental study in dogs; *Clinical Oral Implant Research*, Early View, First Published online on 2011, May 5th; DOI: 10.1111/j.1600-0501.2011.02202.x
 - De Santis E., Botticelli D., Pantani F., Pereira F.P., Beolchini M., Lang N.P.; Bone regeneration at implants placed into extraction sockets of maxillary incisors in dogs; *Clinical Oral Implant Research*, 2011; 430-437; DOI: 10.1111/j.1600-0501.2010.02122.x
 - De Santis E., Lang N.P., Scala A., Viganò P., Salata L.A., Botticelli D.; Healing outcomes at implants installed in grafted sites: an experimental study in dogs; *Clinical Oral Implant Research*, Early View, First Published online on 2011, October 3rd; DOI: 10.1111/j.1600-0501.2011.02326.x
 - Caneva M., Botticelli D., Morelli F., Cesaretti G., Beolchini M., Lang N.P.; Alveolar process preservation at implants installed immediately into extraction sockets using deproteinized bovine bone mineral - an experimental study in dogs; *Clinical Oral Implant Research*, Early View, First Published online on 2011, October 21st; DOI: 10.1111/j.1600-0501.2011.02332.x
 - Caneva M., Botticelli D., Rossi F., Carvalho Cardoso L., Pantani F., Lang N.P.; Influence of implants with different sizes and configurations installed immediately into extraction sockets on peri-implant hard and soft tissues: an experimental study in dogs; *Clinical Oral Implant Research*, Early View, First Published online on 2011, September 29th; DOI: 10.1111/j.1600-0501.2011.02310.x
 - Vignoletti F., De Sanctis M., Sanz M.; Impianti immediati post-estrattivi: fattori critici per la guarigione dei tessuti; *IL Dentista Moderno*, 9:94-114, 2011
 - Farronato D., Santoro G., Canullo L., Botticelli D., Maiorana C., Lang N.P.; Establishment of the epithelial attachment and connective tissue adaptation to implants installed under the concept of "platform switching": a histologic study in minipigs; *Clinical Oral Implant Research*, Early View, First Published online on 2011, April 15th; DOI: 10.1111/j.1600-0501.2011.02196.x
 - Baffone G.M., Botticelli D., Pantani F., Cardoso L.C., Schweikert M.T., Lang N.P.; Influence of various implant platform configurations on peri-implant tissue dimensions: an experimental study in dog; *Clinical Oral Implant Research*, 2011; 438-444; DOI: 10.1111/j.1600-0501.2010.02146.x
 - Canullo L., Pellegrini G., Allievi C., Trombelli L., Annibaldi S., Dellavia C.; Soft tissues around long-term platform switching implant restorations: a histological human evaluation. Preliminary results; *Journal of Clinical Periodontology*, 2011; 38: 86-94; DOI: 10.1111/j.1600-051X.2010.01641.x
 - Canullo L., Iannello G., Netuschil L., Jepsen S.; Platform switching and matrix metalloproteinase-8 levels in peri-implant sulcular fluid; *Clinical Oral Implant Research*, Early View, First Published online on 2011, March 28th; DOI: 10.1111/j.1600-0501.2011.02175.x
 - Della Via C., Canullo L., Allievi C., Lang N.P., Pellegrini C.; Soft tissue surrounding switched platform implants: an immunohistochemical evaluation; *Clinical Oral Implant Research*, Early View, First Published online on 2011, September 29th; DOI: 10.1111/j.1600-0501.2011.02301.x
 - Baffone G.M., Botticelli D., Canullo L., Scala A., Beolchini M., Lang N.P.; Effect of mismatching abutments on implants with wider platforms - an experimental study in dogs; *Clinical Oral Implant Research*, Early View First Published online on 2011, November 2nd; DOI: 10.1111/j.1600-0501.2011.02320.x
 - Canullo L., Pace F., Coelho P., Sciubba E., Vozza I.; The Influence of Platform Switching on the Biomechanical Aspects of the Implant-Abutment System. A Three Dimensional Finite Element Study; *Med Oral Patol Oral Cir Bucal*. 2011 Sep 1;16 (6):e852-6; DOI:10.4317/medoral.17243
 - Canullo L., Iannello G., Götz W.; The influence of individual bone patterns on peri-implant bone loss: preliminary report from a 3-year randomized clinical and histologic trial in patients treated with implants restored with matching-diameter abutments or the platform-switching concept; *International Journal of Oral and Maxillofacial Implants*, 2011 May-Jun;26(3):618-30
 - Serrano-Sánchez P., Calvo-Guirado J.L., Manzanera-Pastor E., Lorrio-Castro C., Bretones-López P., Pérez-Llanes J.A.; The influence of platform switching in dental implants. A literature review; *Medicina Oral Patología Oral Cirugía Bucal*. 2011 May 1;16 (3):e400-5; DOI: 10.4317/medoral.16.e400
 - Bruschi G.B., Crespi R., Capparè P., Bravi F., Bruschi E., Gherlone E.; Localized Management of Sinus Floor Technique for Implant Placement in Fresh Molar Sockets; *Clinical Implant Dentistry and Related Research*, 2011 May 20. [Epub ahead of print]; DOI: 10.1111/j.1708-8208.2011.00348.x
 - Sisti A., Canullo L., Mottola M.P., Iannello G.; A case series on crestal sinus elevation with rotary instruments; *European Journal of Oral Implantology*. 2011 Summer;4(2):145-52
 - Garcia-Fajardo Palacios C.; Sinus Lift. Ottimizzazione dei risultati; *NumeriUno* 10(06), 2011, 04-07
 - Canullo L.; RIGENERAZIONE DI UN SITO POST-ESTRATTIVO con grave deficit osseo vestibolare con idrossiapatite arricchita di magnesio. CASE REPORT CON FOLLOW UP DEL RESTAURO IMPLANTO-PROTESICO A 2 ANNI; *Odontoiatria - Rivista degli Amici di Brugg*, 2: 166-167, 2011
 - Becattelli A., Biscaro L., Ferlin P., Soattin M.; Riabilitazione implanto-protetica di entrambe le arcate mediante Toronto

- Bridge su impianti tiltati a carico immediato; *NumeriUno* 10(06) 2011, 10-12
- Marano G., Tomarelli F.; Carico implantare immediato e condizionamento dei tessuti molli con provvisorio in ceramica; *NumeriUno* 10 (06) 2011, 18-21
 - Avanzo P., Fabrocini L., Avanzo A., Ciavarella D., Lo Muzio L., De Maio R.; Use of intra-oral welding to stabilize dental implants in augmented sites for immediate provisionalization: a case report; *Journal of Oral Implantology*, 2010 Oct 8. [Epub ahead of print]; DOI: 10.1563/AAID-JOI-D-10-00047
 - Dominci A.D.; Solidarizzazione elettronica su impianti a carico immediato: un caso clinico in chirurgia flapless; *Dental Cadmos*, 79(8):545-550, 2011; DOI: 10.1016/j.cadmos.2011.03.002
 - De Paolis G., Quaranta A., Zappia S., Voza L., Quaranta M.; Valutazione clinica e microbiologica di impianti a connessione conometrica rispetto a impianti a connessione esagonale: caso clinico; *Dental Cadmos*, 79(7):443-454, 2011; DOI: 10.1016/j.cadmos.2010.12.010
 - Canullo L., Bignozzi I., Cocchetto R., Cristalli M.P., Iannello G.; Immediate positioning of a definitive abutment versus repeated abutment replacements in post-extractive implants: 3-year follow-up of a randomised multicentre clinical trial; *European Journal of Oral Implantology*, 2010 Winter;3(4):285-96
 - Csonka M.; Carico Immediato di una Cresta Mandibolare Edentula con Tecnica SIMPLE; *Italian Dental Journal*, 2011
 - Canullo L., Baffone G.M., Botticelli D., Pantani F., Beolchini M., Lang N.P.; Effect of wider implant/abutment mismatching: an histological study in dogs; *Clinical Oral Implant Research*, 22(9), 2011:910; DOI: 10.1111/j.1600-0501.2011.02271.x
 - Rossi F., Botticelli D., Salata L.; Bone healing in animal surgically created circumferential defects around submerged implants; *Clinical Oral Implant Research*, 22(9), 2011: 937; DOI: 10.1111/j.1600-0501.2011.02271.x
 - Ricci M., Funel N., Orazio V., Bobbio A., Barone A., Covani U.; Analysis of osteoblastic gene dynamics in the early human mesenchymal cell response to an implant support: an in vitro study; *Clinical Oral Implant Research*, 22(9), 2011: 1071; DOI: 10.1111/j.1600-0501.2011.02271.x
 - Canullo L., Gotz W.; Cell growth on titanium disks treated by plasma of Argon: experimental study; *Clinical Oral Implant Research*, 22(9), 2011: 1082-3; DOI: 10.1111/j.1600-0501.2011.02271.x
 - Bruschi G. B., Crespi R.; Tecniche di espansione ossea in chirurgia implantare; *Quintessenza Edizioni S.r.l.*, 2011, Milano (Anteprima)
 - Avellino W., Milan U., Delle Rose D.; Soluzioni cliniche e tecniche per la realizzazione di un provvisorio full-arch su impianti con funzione immediata; *NumeriUno*, 7: 11-13, 2010
 - Branchi R., Vangi D., Virga A., Guertin G., Fazi G.; Resistance to wear of four matrices with ball attachments for implant overdentures: a fatigue study; *Journal of Prosthodontics*, 19(8):614-619, 2010
 - Bruschi G.B., Crespi R., Capparè P., Gherlone E.; Transcrestal sinus floor elevation: a retrospective study of 46 patients up to 16 years; *Clinical Implant Dentistry and Related Research*, 2010 Oct 26
 - Caneva M., Salata L.A., Scombatti de Souza S., Baffone G., Lang N.P., Botticelli D.; Influence of implant positioning in extraction sockets on osseointegration: histomorphometric analyses in dogs; *Clinical Oral Implant Research* 21: 43-49, 2010
 - Caneva M., Salata L.A., Scombatti de Souza S., Bressan E., Botticelli D., Lang N.P.; Hard tissue formation adjacent to implants of various size and configuration immediately placed into extraction sockets: an experimental study in dogs; *Clinical Oral Implant Research*, 21(9):885-90, 2010
 - Caneva M., Botticelli D., Stellini E., Souza S.L., Salata L.A., Lang N.P.; Magnesium-enriched hydroxyapatite at immediate implants: a histomorphometric study in dogs; *Clinical Oral Implant Research*, Early View, first published online 2010 Dec 9
 - Caneva M., Botticelli D., Salata L.A., Scombatti de Souza S., Carvalho Cardoso L., Lang N.P.; Collagen membranes at immediate implants: a histomorphometric study in dogs; *Clinical Oral Implant Research*, 21(9):891-7, 2010
 - Caneva M., Botticelli D., Salata L.A., Scombatti de Souza S.L., Bressan E., Lang N.P.; Flap vs. "Flapless" surgical approach at immediate implants: a histomorphometric study in dogs; *Clinical Oral Implant Research*, 21 (12):1314-1319, 2010
 - Canullo L., Quaranta A., Teles R.P.; The microbiota associated with implants restored with platform switching: a preliminary report; *Journal of Periodontology*, 81:403-411, 2010
 - Canullo L., Rossi Fedele G., Iannello G., Jepsen S.; Platform switching and marginal bone-level alterations: the results of a randomized controlled trial; *Clinical Oral Implant Research*, 21:115-121, 2010
 - Canullo L., Bignozzi I., Cocchetto R.; "One abutment-one time": optimizing platform-switching concept. Three-year controlled prospective study; *Clinical Oral Implant Research*, 21 (10): 1085, 2010
 - Canullo L.; Caso clinico: agenesia dell'incisivo laterale superiore destro; *Italian Dental Journal*, 4: 16, 2010
 - Canullo L., Cocchetto R., Loi I.; Peri-implant tissues remodeling: scientific background & clinical implications; *Quintessenza Edizioni S.r.l.*, 2010, Milano (Anteprima)
 - Canullo L., Sisti A.; Early implant loading after vertical ridge augmentation (vra) using e-ptfe titanium reinforced membrane and nanostructured hydroxyapatite: 2-year prospective study; *European Journal of Oral Implantology*, 3(1):59-69, 2010
 - Canullo L., Patacchia O., Sisti A., Heinemann F.; Implant restoration 3 months after one stage sinus lift surgery in severely resorbed maxillae: 2-year results on a multicenter prospective clinical study; *Clinical Implant Dentistry and Related Research*, Early view - Published online in ahead of printing, 21-10-2010
 - Ciccì M., Risitano G., Maiorana C., Herford A., Oteri G., Ciccì D.; "Toronto" screwed mandibular overdenture on dental implants: fem and von mises analysis of stress distribution; *The Journal of Implants and Advanced Dentistry*, 2(9): 41-58, 2010
 - Covani U., Marconcini S., Santini S., Cornelini R., Barone A.; Immediate restoration of single implants placed immediately after implant removal. A case report; *International Journal of Periodontics & Restorative Dentistry*, 30:639-645, 2010
 - Crespi R., Capparè P., Gherlone E.; Osteotome sinus floor elevation and simultaneous implant placement in grafted biomaterial sockets: 3 years of follow-up; *Journal of Periodontology*, 81:344-349, 2010
 - Crespi R., Capparè P., Gherlone E.; A 4-year evaluation of the peri-implant parameters of immediate loaded implants placed in fresh extraction sockets; *Journal of Periodontology*, 81 (11):1629-1634, 2010
 - Crespi R., Capparè P., Gherlone E.; Immediate loading of dental implants placed in periodontally infected and non infected sites in humans: a four years follow-up clinical study; *Journal of Periodontology*, 81 (8):1140-1146, 2010
 - Crespi R., Capparè P. and Gherlone E.; Fresh-socket implants in periapical infected sites in humans; *Journal of Periodontology*, 81:378-383, 2010
 - Galli C., Passeri G., Piemontese M., Lumetti S., Manfredi E., Carra M.C., Macaluso G.M.; Phosphoserine-poly (lysine) coatings promote osteoblastic differentiation and wnt signaling on titanium substrates; *Clinical Oral Implant Research*, 21(10): 1172, 2010
 - Mantoan G.; Le corone provvisorie immediate su impianti global (metodica clinica); *NumeriUno*, 7: 17-18, 2010
 - Momen A. A., Hadeel M. I., Ahmad H. A.; Platform switching for marginal bone preservation around dental implants: a systematic review and meta-analysis; *Journal of Periodontology*, 81 (10):1350-1366, 2010
 - Pantani F., Botticelli D., Rangel Garcia I. Jr., Salata L.A., Jayme Borges G., Lang N. P.; Influence of lateral pressure to the implant bed on osseointegration: an experimental study in dogs; *Clinical Oral Implant Research*, 21(11): 1264-70, 2010
 - Passeri G., Cacchioli A., Ravanetti F., Galli C., Elezi E., Macaluso G.M.; Adhesion pattern and growth of primary human osteoblastic cells on five commercially available titanium surfaces; *Clinical Oral Implant Research* 21: 756-765, 2010
 - Raddi F.; Analisi comparativa test di resistenza a fatica sperimentali e virtuali; *Relazione interna*, Sweden & Martina, 2010
 - Scala A., Botticelli D., Oliveira J.A., Okamoto R., Garcia Rangel I. Jr., Lang N.P.; Early healing after elevation of the maxillary sinus floor applying a lateral access - a histological study in monkeys; *Clinical Oral Implant Research*, 21 (12): 1320-6, 2010
 - Silvasan M.H.; Timing of dental implant loading - a literature review; *Implants - Oemus*, 11 (3): 06-16, 2010
 - Sbordone L., Levin L., Guidetti F., Sbordone C., Glikman A., Schwartz-Arad D.; Apical and marginal bone alterations around implants in maxillary sinus augmentation grafted with autogenous bone or bovine bone material and simultaneous or delayed dental implant positioning; *Clinical Oral Implants Research*, 2010 Nov 19. [Epub ahead of print]



rev. 09-15



Sweden & Martina S.p.A.

Via Veneto, 10
35020 Due Carrare (PD), Italy
Tel. +39.049.9124300
Fax +39.049.9124290
info@sweden-martina.com
www.sweden-martina.com

Sweden & Martina Mediterranea S.L.

Sorolla Center, Oficina 801
Avda Cortes Valencianas 58, 8pl
46015-Valencia, España
Tel. +34.96.3525895
Tel. 900993963
info.es@sweden-martina.com

Sweden & Martina Inc.

One Embarcadero Center
Suite#504
San Francisco, CA94111
USA
Toll free (844)8MARTINA/844.862.7846
info.us@sweden-martina.com

The implants, prosthetic components and surgical instruments illustrated in this manual are medical devices manufactured by Sweden & Martina SpA, are compliant with the UNI EN ISO 9001:2008/UNI EN 13485:2012 standards, and are registered as CE Mark (Class I) and CE Mark 0476 (Class IIA and Class IIB) in accordance with the European Medical Devices Directive 93/42/EEC and European Directive 2007/47/EC. They comply with QSR 21 CFR part 820, and are approved by the FDA.

Sweden & Martina production facilities manufacture medical devices in accordance with the cGMPs applicable in the USA and other countries.



Some products may not be available on all markets.

All brand names present in this manual are the property of Sweden & Martina, except for those products for which other indications are given. These products are intended for dental clinics and dental technology laboratories, and are not intended for direct sale to patients.

It is prohibited to sell, duplicate or disclose the products illustrated in this manual without the prior written consent of Sweden & Martina SpA. For further information on the products illustrated, including indications, contraindications, warnings, precautions and potential side-effects, please consult the Sweden & Martina SpA website.

Contents are correct at the time of publication. Please contact Sweden & Martina SpA for information on any subsequent updates.